



# Ultra-Urban Green Infrastructure Guidelines



## Acknowledgments

The Ultra-Urban Green Infrastructure Guidelines manual was a partnership between City and County of Denver (CCD) and Urban Drainage and Flood Control District (UDFCD). CCD and UDFCD specifically acknowledges the following individuals who contributed to the publication of this guide:

### Project Leads

Sarah Anderson, Denver Public Works

Holly Piza, Urban Drainage and Flood Control District

### United States Environmental Protection Agency

As part of this effort, the United States Environmental Protection Agency (EPA) provided contractor support for the development of the checklists in this manual. Tetra Tech prepared plan review, construction inspection, and maintenance checklists as well a number of the renderings. The EPA is committed to providing technical assistance to communities working to overcome the barriers to green infrastructure. For more information please visit: [http://water.epa.gov/infrastructure/green\\_infrastructure/gi.support.cfm](http://water.epa.gov/infrastructure/green_infrastructure/gi.support.cfm).

### Team Members:

#### Public Works

Jose Cornejo

Joe Cordts

Robert Dorrah

Saeed Farahmandi

Chris Fraguada

Steve Forvilly

Ashlee Grace

Walt Hime

Michael Holm

Matt MacLachlan

Darren Mollendor

Raul Rodriguez

Brian Schat

Justin Schmitz

Sam Stevens

Stephen Vondreele

Yuan Zhixu

#### North Denver Cornerstone Collaborative

Celia Vanderloop

Todd Wenskoski

#### Denver Parks and Recreation

Rob Davis

Sara Davis

Cincere Eades

Eric Huetig

Jim Myer

Brian Wethington

#### Community Planning and Development

Samantha Suter

Tim Watkins

#### Development Services

Eric Osmundsen

Alan Sorrel

#### Department of Environmental Health

Jon Novick

Paul Schmiechen

John Student

#### Urban Drainage and Flood Control District (UDFCD)

Ken MacKenzie

The following members of the project consultant team contributed significant time and effort to the preparation of this guide:

#### Muller Engineering

Jim Wulliman

Chris Kroeger

Jon Yager

#### Environmental Protection Agency (EPA)

Stacey Erikson

#### Stream Design

Paul Thomas

Jesse Clark

Claire Kesecker

Scott Ogden (Plant Driven Design)

#### Tetra Tech

Martina Frey

Jason Wright

1. Introduction	1
1.1 Project Purpose	1
1.2 Audience	1
1.3 Regional Considerations	1
<b>2. Site-Scale Green Infrastructure Practice Selection, Design, and Maintenance</b>	<b>3</b>
2.1 Project Purpose	3
2.2 Design Criteria	4
2.2.1 Sizing	4
2.2.2 Pedestrian Considerations and Geometry	5
2.2.3 Materials	8
2.2.4 Vegetation	11
2.3 Designing for Maintenance	12
2.4 Accommodating Utilities	12
2.4.1 Water Services	13
2.5 Maintenance Responsibility	14
2.6 Construction Observation	14
<b>3. References</b>	<b>16</b>
<b>4. Streetside Stormwater Planter Fact Sheet</b>	<b>17</b>
4.1 Description	17
4.2 Uses and Recommendations	18
4.3 Planter Aesthetics and Urban Design	19
4.4 Geometry	19
4.5 Planter Design Considerations	20
4.6 Vegetation	21
4.7 Streetside Stormwater Planter Details	23
<b>5. Bumpout Stormwater Planter Fact Sheet</b>	<b>30</b>
5.1 Description	30
5.2 Uses and Recommendations	31
5.3 Planter Aesthetics and Urban Design	32
5.4 Geometry	32

5.5 Planter Design Considerations - . . . . .	33
5.6 Vegetation - . . . . .	34
5.7 Bumpout Stormwater Planter Details - . . . . .	36
<b>6. Green Gutter Fact Sheet</b>	<b>44</b>
6.1 Description - . . . . .	44
6.2 Uses and Recommendations - . . . . .	45
6.3 Green Gutter Aesthetics and Urban Design - . . . . .	45
6.4 Geometry - . . . . .	46
6.5 Green Gutter Design Considerations - . . . . .	47
6.6 Vegetation - . . . . .	47
6.7 Green Gutter Details - . . . . .	48
<b>7. Green Alley Fact Sheet</b>	<b>55</b>
7.1 Description - . . . . .	55
7.2 Uses and Recommendations - . . . . .	56
7.3 Green Alley Aesthetics and Urban Design - . . . . .	56
7.4 Geometry - . . . . .	56
7.5 Green Alley Design Considerations - . . . . .	56
7.6 Green Alley Details - . . . . .	57
<b>8. Tree Trench/Pit Fact Sheet</b>	<b>60</b>
8.1 Description - . . . . .	60
8.2 Uses and Recommendations - . . . . .	61
8.3 Tree Trench/Pit Aesthetics and Urban Design - . . . . .	62
8.4 Use of Grates - . . . . .	62
8.5 Geometry - . . . . .	63
8.6 Tree Trench/Pit Design Considerations - . . . . .	64
8.7 Vegetation - . . . . .	66
8.8 Tree Trench/Pit Details - . . . . .	67
Appendix A: Development Plan Review Checklist - . . . . .	75
Appendix B: Inspection and Maintenance Checklist - . . . . .	88
Appendix C: Plant Lists - . . . . .	96
Appendix D: Forestry Memo - . . . . .	99

Figure 1. Inlet Width based on Drainage Area	5
Figure 2. Example of Stormwater BMP A	6
Figure 3. Example of Stormwater BMP B	6
Figure 4. Planter Length vs. Street Slope	7
Figure 5. Back Side of Forebay	12
Figure 6. Failing Stormwater System	12
Figure 7. Streetside Stormwater Planter	17
Figure 8. Streetside Stormwater Planter Isometric Diagram	18
Figure 9. Streetside Stormwater Planter City Block Diagram	19
Figure 10. Streetside Stormwater Planter in Urban Landscape	19
Figure 11. Basic Grass Cover Planting Plan	21
Figure 12. Western Prairie Planting Plan	22
Figure 13. Modern Matrix Planting Plan	22
Figure 14. Streetside Stormwater Planter Details	23-29
Figure 15. Bumpout Stormwater Planter	30
Figure 16. Bumpout Stormwater Planter Isometric Diagram	31
Figure 17. Bumpout Stormwater Planter City Block Diagram	32
Figure 18. Bumpout Stormwater Planter in Urban Landscape	32
Figure 19. Basic Grass Cover Planting Plan	34
Figure 20. Western Prairie Planting Plan	35
Figure 21. Modern Matrix Planting Plan	35
Figure 22. Bumpout Stormwater Planter Details	36-43
Figure 23. Green Gutter	44
Figure 24. Green Gutter Isometric Diagram	45
Figure 25. Maximum Length of Green Gutter Section	46
Figure 26. Green Gutter Details	48-54
Figure 27. Green Alley	55
Figure 28. Green Alley Details	57-59
Figure 29. Tree Trench/Pit	60
Figure 30. Tree Trench/Pit Profile Diagram	61
Figure 31. Tree Trench/Pit City Block Diagram	62
Figure 32. Tree Trench/Pit In Urban Landscape	62
Figure 33. Tree Trench Example A	63
Figure 34. Tree Trench Example B	63
Figure 35. Tree Trench Example C	63

# LIST OF FIGURES + TABLE

Figure 36. Pre-Treatment Filter Area based on Drainage Area - - - - -	65
Figure 37. Tree Trench/Pit Details - - - - -	67-74
Table. 1 Watershed Area - - - - -	3
Table 2. Material Specification Summary - - - - -	10

# 1. INTRODUCTION

## 1.1 PROJECT PURPOSE

The City and County of Denver is making green infrastructure a fundamental part of the city's long-term stormwater management strategy by looking at ways to incorporate large-scale green infrastructure with small or site-scale green infrastructure. On a large-scale, green infrastructure refers to a network of parks, open spaces, drainageways, and floodplains which help mitigate the impacts caused by impervious (hard) surfaces. Impervious surfaces disrupt the natural infiltration of water and increase both the volume and peak rate of stormwater runoff which leave urban watersheds prone to flooding, erosion, and increased pollution levels.

Site-scale green infrastructure refers to smaller, engineered, structural practices which are necessary to mitigate the impacts urbanization has on the hydrologic cycle. These systems mimic larger natural systems and use vegetation, soils, and roots to slow and filter stormwater runoff. Site-scale green infrastructure best management practices (BMPs) are the focus of this guide and fact sheets for streetside stormwater planters, bumpout stormwater planters, green gutters, green alleys, and tree pit/tree trenches are discussed. The fact sheets and conceptual construction details herein provide the user with technical guidance for designing, installing, and maintaining site-scale green infrastructure. Benefits of green infrastructure, regardless of scale, include improved air and water quality, reduced flooding risks, urban heat island effect mitigation, reduced energy demands, climate change resiliency, and enhanced community livability.

Each practice within this guide has been chosen for its suitability in Denver's ultra-urban environment and in particular for use in the right-of-way (ROW). Treating street runoff is critical to improving the health of Denver's urban waterways. Not only are streets a major source of stormwater runoff, they also represent the largest source of urban pollutants including sediment, heavy metals, automotive fluids, nutrients, and trash. As part of the stormwater conveyance system, roads collect and carry runoff directly to the underground storm drain

network which then pipes these pollutants directly to receiving waterways, often without treatment. While the road network represents one of the largest urban pollution and runoff sources, it also represents one of the best opportunities for the use of site-scale green infrastructure. These practices can be used on new streets and during repaving or reconstruction of streets, alleys, medians, and parking lots.

Each practice in this guide is also suitable for use on ultra-urban private residential and commercial development and redevelopment. Green infrastructure can enhance the livability of a space, increase property values and retail sales when integrated seamlessly into courtyards, plazas, and other public spaces.

## 1.2 AUDIENCE

The practices illustrated in this guide build upon the practices discussed in Urban Drainage and Flood Control District's (UDFCD) Urban Storm Drainage Criteria Manual, Volume 3 (USDCM's Vol. 3) and were created to provide guidance for city staff, engineers, planners, landscape architects, and developers for use on both public and private projects where space is limited. This guide provides details that have not been previously approved in Denver and thus is intended to expedite the review and approval process when choosing these practices. Investment from both the public and private sector is needed to achieve the economic and environmental benefits of a green infrastructure program.

## 1.3 REGIONAL CONSIDERATIONS

Special consideration has been given to providing guidance suitable for Denver's semi-arid climate and unique system of administering surface water rights.

### SEMI ARID CLIMATE

Denver's semi-arid climate requires modifying green infrastructure practices adopted from other U.S. locations. Stormwater controls typically must be xeriscaped with a focus

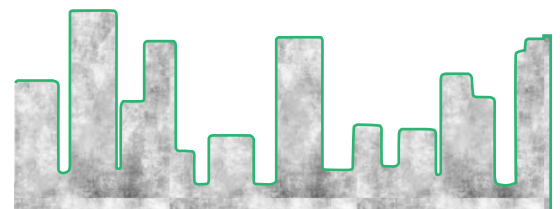



## 1. INTRODUCTION

on native plants, because they use less water and perform better in the semi-arid environment. A mix of North American natives can be utilized to develop a plant palette that will tolerate both periodic flooding and drought. Though native species will likely need supplemental irrigation during establishment, nonnative plants generally will not survive without irrigation (WEF 2014).

Additionally, rain events in Denver tend to be high intensity and infrequent, resulting in a water quality event that is heavy with sediments and other pollutants that have accumulated since the previous storm. As a result, forebays, presedimentation basins or other forms of pretreatment are recommended to remove some of the particulate matter before it reaches the green infrastructure facility.

### **SURFACE WATER RIGHTS**

Surface water in Colorado is administered through a priority system, the Doctrine of Appropriation, where “first in time” equals “first in right.” Water users with earlier water rights decrees (senior rights) have first right in times of short supply and can fill their needs before the junior rights users can begin to use water. The Colorado Division of Water Resources (DWR) administers this program and in 2011 circulated a memorandum titled “Administrative Approach for Storm Water Management.” This document details what administrative allowances the State is currently willing to make to accommodate detention and infiltration as stormwater management activities. Specific limitations state that stormwater detention and infiltration areas must release all the water detained from the site within 72 hours of the end of the precipitation event, should be designed to release the water from the site as quickly as downstream conditions allow, and must be designed to minimize consumption from vegetation.

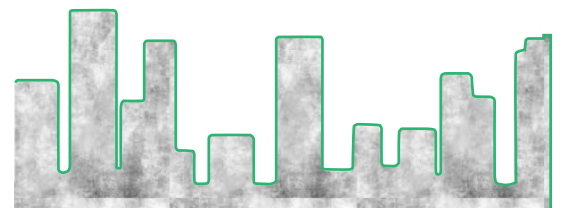

# 2. SITE SCALE GREEN INFRASTRUCTURE PRACTICE, SELECTION, DESIGN, AND MAINTENANCE

## 2.1 PROJECT PURPOSE

The selection and design of green infrastructure practices are driven by a site's physical characteristics including soils, contributing drainage area, groundwater, and development conditions within a watershed. UDFCD (2013) describes physical site characteristics that support or constrain green infrastructure practice selection.

### SOILS

Soils with good permeability, typically associated with Hydrologic Soil Groups (HSGs) A and B, provide opportunities for infiltration of runoff and are well-suited for infiltration-based practices such as streetside stormwater planters, bumpout stormwater planters, green gutters, tree trenches/pits, and green alleys often without the need for an underdrain system. Even when soil permeability is low, these types of practices may be feasible if soils are amended to increase permeability or if an underdrain system is used. In some cases, however, soils limit the use of infiltration-based practices. When soils with moderate to high swell potential are present, infiltration should be avoided to minimize damage to adjacent structures due to water-induced swelling. In these cases, filtration designs can still be used if an impermeable liner and underdrain system are included in the design. In all cases, a geotechnical engineer should be consulted when designing infiltration practices near structures to evaluate the suitability of soils for different practice types and establish minimum

distances between infiltration practices and structures. Regardless of soil type, a curtain liner may be required if the facility is located close to a building with a basement.

### WATERSHED AREA

Best management practices (BMPs) must be designed for the area that drains to the BMP. Undersized BMPs will collect and pond water more frequently impacting the health and appearance of vegetation. Additionally, undersized best BMPs will receive more sediment and debris which will require additional maintenance or cause premature failure. Adequate space for a BMP, especially for retrofit projects, may not be available. Table 1 shows approximate water quality capture volume (WQCV) volume provided by some of the BMPs described in this manual. This table is provided for planning level purposes only. The actual volume provided will vary based on longitudinal slope, actual dimensions for specific installations, and other site-specific conditions.

### GROUNDWATER

Shallow groundwater on a site presents challenges for green infrastructure practices that rely on infiltration and for facilities that are intended to be dry between storm events. Shallow groundwater may limit the ability to infiltrate runoff or result in unwanted subsurface storage of groundwater in areas intended for storage of the WQCV (e.g., the porous sub-base of a

TABLE 1. Watershed Area (Source: UDFCD. 2015.)

Description	Approximate Volume Provided (ft <sup>3</sup> )	Approximate Area Treated (ft <sup>2</sup> )
Streetside stormwater planter	190	4,680
Streetside stormwater planter, no parking	230	5,610
Streetside bumpout stormwater planter, corner	350	8,480
Streetside bumpout stormwater Planter, mid-block	310	7,930
Tree trench (three trees, 25 feet O.C. with one control structure, 2% slope)	240	5,770
Tree trench (two trees, 25 feet O.C. with one control structure, 2% slope)	160	3,860
Tree trench (one tree with one control structure, 2% slope)	70	1,630

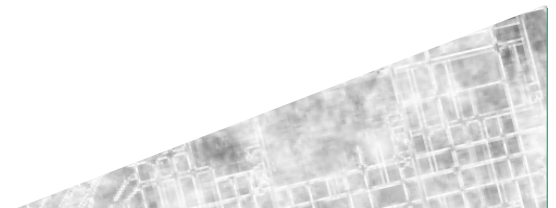

## 2.SITE-SCALE GREEN INFRASTRUCTURE PRACTICE, SELECTION, DESIGN & MAINTENANCE

permeable pavement system or in the bottom of an otherwise dry facility such as an extended detention basin). Groundwater quality protection is an issue that should be considered for infiltration-based practices.

Infiltration practices may not be appropriate for land uses that involve storage or use of materials that have the potential to contaminate groundwater underlying a site (i.e., “hot spot” runoff from fueling stations, materials storage areas, etc.). If groundwater or soil contamination exists on a site (i.e., a brownfield), and the contamination will not be remediated or removed as a part of construction, it may be necessary to avoid infiltration based practices or use a durable liner to prevent infiltration into areas contaminated with pollutants that could be mobilized by stormwater.

### WATERSHED DEVELOPMENT ACTIVITIES

When development in the watershed is phased or when erosive conditions (steep slopes, sparse vegetation, or sandy soils) exist in the watershed, a treatment train approach may be appropriate. A treatment train approach uses BMPs in a series and treats runoff by physical, chemical, and biological processes. By including as many removal mechanisms as possible in each BMP train, the ability to remove particular pollutants is increased.

Practices that use filtration should follow other measures to collect sediment loads (e.g., a forebay). For phased developments, these measures must be in place until the watershed is completely stabilized. When naturally erosive conditions exist in the watershed, these measures should be permanent. The designer should consider existing, interim and future conditions to select the most appropriate practices.

### 2.2 DESIGN CRITERIA

These criteria are provided to assist the design team. Details provided in this manual are not intended for construction plans. The design team must consider site-specific conditions and constraints and add an appropriate level of detail to the

construction plans including existing utilities, spot elevations, and structural reinforcement for each installation. Plan review checklists provided in Appendix A should also be used to assist with the design.

#### 2.2.1 SIZING

##### WATER QUALITY CAPTURE VOLUME AND PEAK FLOW RATE

The required WQCV for the upstream area draining to a green infrastructure BMP shall be computed using the procedures in Urban Drainage and Flood Control District’s (UDFCD) Urban Storm Drainage Criteria Manual, Volume 3 (USDCM Vol. 3). Additionally, the filter surface area for streetside stormwater planters, bumpouts and green gutters shall be sized at no less than 2% of the tributary area. When it is beneficial to estimate a peak flow rate associated with the water quality event for sizing hydraulic components, the rational method should be used as described in USDCM Volume 1 using the following parameters:

*Time of concentration,  $T_c = 5$  minutes*

*Water quality rainfall intensity at a  $T_c$  of 5 minutes =  
2.04 inches per hour (iph)*

*Runoff coefficient for impervious surfaces,  $C_{wq} = 0.84$*

#### INLET SIZING

Inlet design is a critical component of many of the green infrastructure BMPs. The street inlet must be located at the upstream end of the BMP, must convey runoff from the curb and gutter across the step-out zone, and be sized to convey the water quality event assuming an appropriate amount of debris blockage. The inlet must also be designed to function in concert with a forebay or pretreatment filter, which is intended to capture the majority of litter, debris, and sediment entering the BMP.

Inlet layout is illustrated in plan and section in the fact sheet details. The inlet features a 2-inch depression in the flow line of the gutter to help direct runoff into the opening and reduce bypass flow. The inlet is shown as a chase type structure with a cover plate. The interior portion of the inlet box (bottom slab of the chase drain) should be sloped as indicated in the details

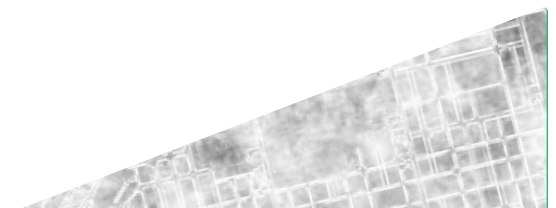

## 2.SITE-SCALE GREEN INFRASTRUCTURE PRACTICE, SELECTION, DESIGN & MAINTENANCE

and a drop off should be provided from the invert of the chase drain to the sediment collection pad or filter surface (for tree trenches), which should be at least 4 inches below the water quality water surface. This allows for some amount of debris and sediment buildup without reducing stormwater conveyance through the inlet.

The opening length of inlet required will vary depending on flow rate and longitudinal slope. Figure 1 can be used to determine the length of inlet required for a given upstream area (assumed to be fully impervious). This figure is based on Equation 3 from the Technical Memorandum, Hydraulic Efficiency of Inlets Common to the UDFCD Region (UDFCD, 2011) for continuous grade applications. A debris factor of 10 percent (as recommended in the Technical Memorandum ) is built in.

### 2.2.2 PEDESTRIAN CONSIDERATIONS AND GEOMETRY

All of the water quality practices provided in this manual are designed for an urban setting and require design considerations for the safety of the public. Considerations specific to individual BMPs are included in the fact sheets. The following pertain to multiple green infrastructure practices.

### PLANTER EDGE BARRIER

Edge barriers are applicable for various types of planters that include open landscape areas and are depressed below pedestrian areas. A visual and physical barrier along the perimeter of a planter is necessary to discourage deliberate or inadvertent entry by pedestrians because the top of the planting media in the planters is depressed below the elevation

FIGURE 1. Inlet width based on drainage are.

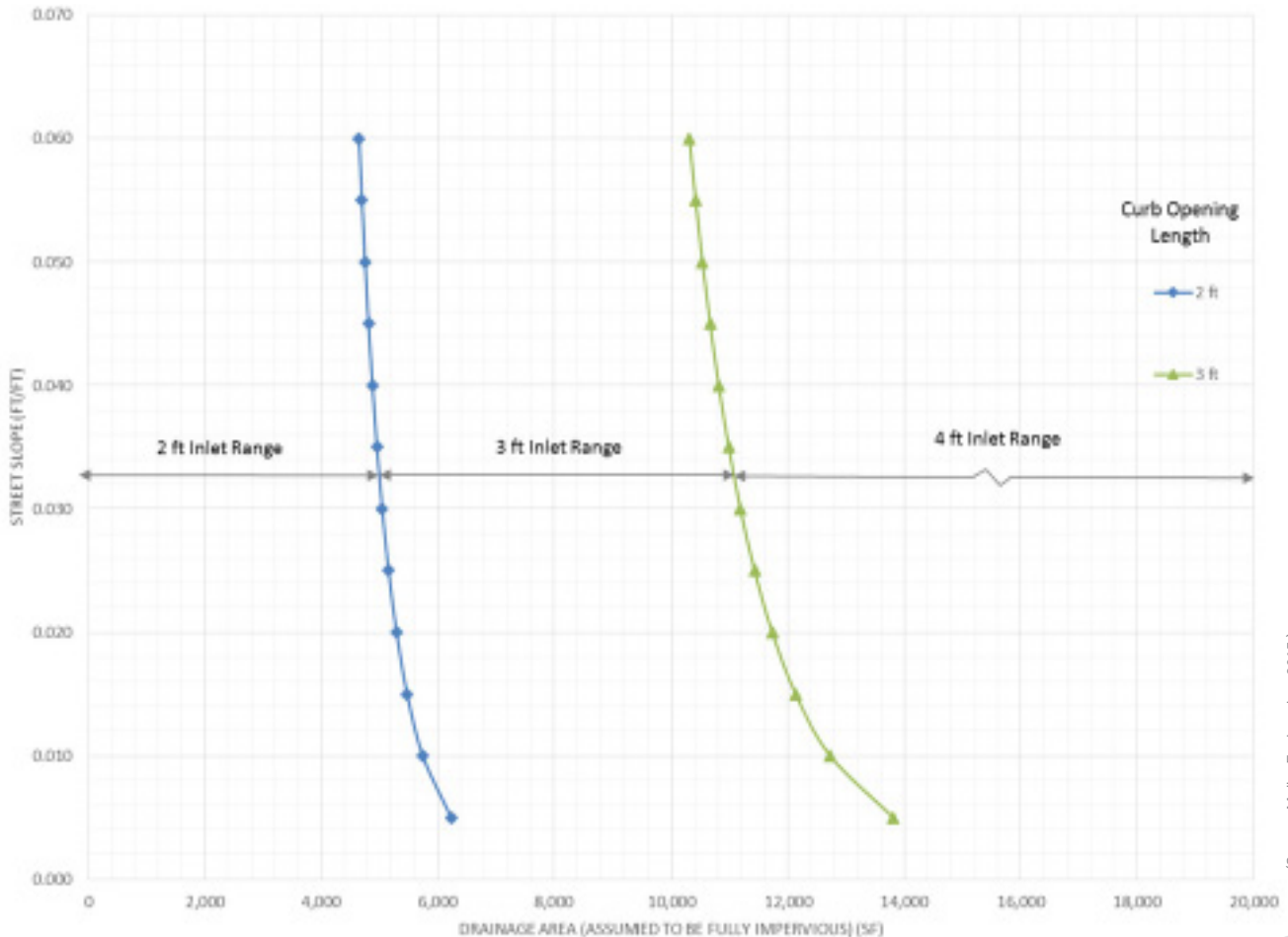

(Source: Muller Engineering, 2015.)



## 2.SITE-SCALE GREEN INFRASTRUCTURE PRACTICE, SELECTION, DESIGN & MAINTENANCE

of the sidewalk, typically by ten inches or more. In general, a 6 inch or higher barrier parallel to the sidewalk is recommended on the “long” sides of the planter parallel to the street and a 15 inch or higher barrier is required on the “short” sides of the planter perpendicular to the street. These barriers may be concrete or stone curbs/walls, metal railings, or a combination of the two. The maximum barrier height is recommended to be 30 inches. Barriers higher than 6 inches are not appropriate for BMPs located within a street section, such as green gutters. Examples of barriers are shown in Figures 2 and 3.

Pedestrian safety must also be kept in mind when establishing the maximum depth of the planter, as measured from the adjacent pavement/walking surface to the top of the bioretention media. This depth should generally not exceed 16 inches. In general, it is recommended that the top of the bioretention media be flat, regardless of street slope. This reduces longitudinal flow velocities and the potential for erosion of the media. The depth from the sidewalk to the top of the media will decrease as the street slopes in a downstream direction, “raising” vegetation relative to pedestrians.

### SIDEWALK DRAINAGE

Small openings or gaps in the edge barrier opposite the street are typically provided in planters to provide drainage from the sidewalk into the planter. These are typically openings 1 to 2 inches high and 4 to 6 inches long or gaps in the sidewall 1 to 2 inches wide. Openings are recommended at approximately 10 feet intervals and the furthest downstream opening should be at least 10 feet from the downstream end of the planter to reduce outflows from the opening in events exceeding the water quality event.



FIGURE 2. Example of stormwater planter

### STEP-OUT ZONE

Denver requires a 2.5 foot step-out zone behind the back of curb in all locations where parking is (or will be) adjacent to the curb. Where parking is not planned adjacent to the curb, a 1.5 foot setback is required. Details in this manual show a 1.5 foot stepout for bumpout stormwater planters and a 2.5 foot stepout for streetside planters. This can be reduced to 1.5 feet where the streetside planter is not located adjacent to parking. Stepout zones are not required on green gutters.

### PLANTER LENGTH

Planter length is set as necessary to:

1. Provide periodic access from one side of a planter to the other;
2. Provide required treatment volume; and
3. Contain stormwater in the planter on sloping streets.

The maximum length of streetside and bumpout stormwater planters based on pedestrian access is 40 feet. Denver street standards associated with raised objects call for an access path every 40 feet to provide reasonable access for pedestrians to exit a vehicle and get to the sidewalk. All access points adjacent to streetside and bumpout stormwater planters shall provide a minimum of 4 feet clear. This means that if signage or any other object is placed in the access path, distance between planters must increase to provide a minimum clear width of 4 feet. Although these points are not part of the ADA accessible route, it is recommended that (when required) reserved accessible parking spots be located adjacent to access points. In highly active areas it may be appropriate to provide more frequent or wider access points. Existing utilities may also limit



FIGURE 3. Example of stormwater planter



## 2.SITE-SCALE GREEN INFRASTRUCTURE PRACTICE, SELECTION, DESIGN & MAINTENANCE

the length of the planter. Access points for green gutters should be evaluated for each site. Access points within green gutters should not invite a pedestrian to cross at an inappropriate location. Where green gutters are located adjacent to parallel parking, a maximum spacing of 40 feet is appropriate and access points should be at grade with the parking space and at least five feet wide. Where green gutters are located adjacent to a travel lane, a length of 40 feet may be exceeded as long as consideration is given to the required length to retain the water quality water surface based on street slope. Alternatively, drops can be used to “stairstep” the WQCV as shown in the details, providing a long continuous green gutter while maximizing capture volume.

The maximum length of streetside and bumpout stormwater planters based on street slope is shown in Figure 4, assuming sidewalk drains are provided as shown in the details. This is

the maximum length the planter can be and still contain the water quality volume without spilling out of the sidewalk drains. In rainstorms greater than the water quality event, runoff will overflow back to the curb and gutter through a spillway, as described below.

On streets with steeper slopes (greater than 2 percent), or if sidewalk drains are not used to provide drainage into the planter, the top of the walls can be designed to be horizontal and parallel to the top of the media for the whole length of the planter. In this case, the water quality water surface can be retained within the planter even with steeper street slopes and a planter length up to 40 feet can be used rather than limiting length based on Figure 4. A spillway should still be provided as described below, with the crest at or above the water quality water surface, to direct flows in excess of a water quality event back to the curb and gutter.

FIGURE 4. Planter length versus street slope.

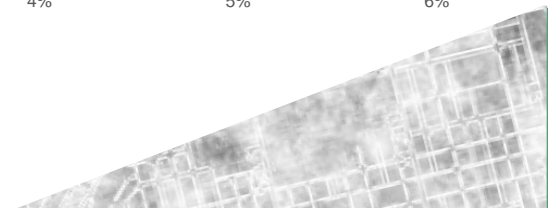
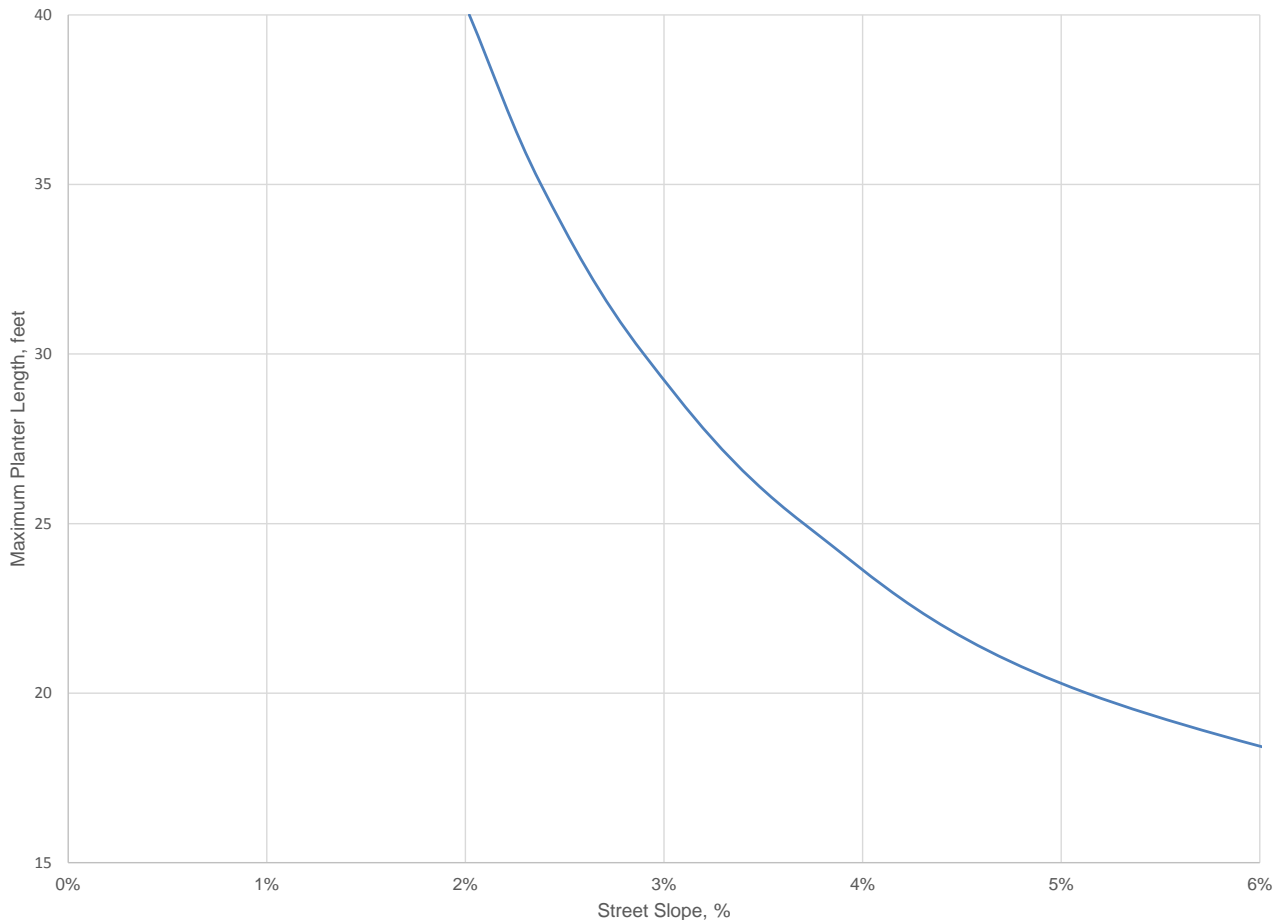

## 2.SITE-SCALE GREEN INFRASTRUCTURE PRACTICE, SELECTION, DESIGN & MAINTENANCE

### SPILLWAY

In storms exceeding the water quality event, the water surface in planters will rise above the water quality water surface and at some point will spill out of the planter at the downstream end. For this reason, a break in the side wall closest to the street is recommended, as shown in the details, to allow excess flows to spill back to the curb and gutter. The recommended spillway length is 2 feet, although this could be adjusted by the designer. Spillways are not recommended for a green gutter. If the storm is very intense, runoff may spill out of drain openings on the sidewalk side of the planter.

### 2.2.3 MATERIALS

See Table 2 (page 10) for a summary of material specifications for bioretention including underdrain pipe, filter material, and liners for all BMPs presented in this manual.

### BIORETENTION MEDIA

Bioretention media should be consistent with the criteria outlined in the specifications in Table 2 of this section. A minimum media depth of 18 inches is appropriate for most applications. When trees are used, increase the depth of the media to 36 inches.

### UNDERDRAIN AND FILTER MATERIAL

An underdrain system is used to collect and drain the filtered stormwater from beneath the bioretention media or permeable pavement system. The underdrains should be slotted wall PVC pipe within the BMP and transition to solid wall PVC pipe outside of the BMP. The underdrain pipe, both slotted and solid wall, and the filter material specified, should be consistent with the criteria outlined in the Bioretention Fact Sheet in Volume 3 of the USDCM.

### FLOW CONTROL STRUCTURE

A flow control structure is shown at the downstream end of several of the BMP underdrains to house an orifice to limit outflow to the release rate specified in the USDCM Vol. 3. It also provides a means of overflow and an opportunity to monitor and adjust the top of the WQVC within the BMP.

### PLANTER WALLS

Walls surrounding the planters and green gutters are recommended to contain the media and WQCV, to facilitate easier maintenance and constructibility (especially in retrofit projects), and to decrease the potential for saturation of the adjacent soils. Several options for wall construction are available in today's marketplace. Walls can be constructed out of concrete; both cast in place or pre-cast, and can be colored, stained, and stamped. Walls may also be constructed out of blocks/bricks with mortar and could integrate stone elements. Regardless of the type of construction, a structural engineer shall be responsible for designing and detailing the walls and other structural elements of the BMPs.

The designer should take into account the desired aesthetic, structural integrity, and street slope, among other factors, when laying out and designing planter walls. The details show the bottom of the walls even with the bottom of the planting media with an 8 inch deep excavation between the walls to place the layer of filter material. Alternatively, the walls could extend to the bottom of the 8 inch deep filter layer. In either case, the designer needs to specify subgrade conditions necessary to ensure a suitable foundation for the walls and reduce the potential for settling.

### LINERS

It is the responsibility of the designer/geotechnical engineer to specify whether a liner is required for a green infrastructure BMP. Liners are appropriate in areas of contaminated groundwater, where expansive soils pose a threat to nearby structures, and in other locations as determined by a geotechnical engineer. Liners reduce infiltration of stormwater and do not provide as much volume reduction compared to unlined systems. For this reason, liners are associated with a lesser treatment level and should not be used unless necessary. Liners can consist of a concrete bottom with appropriate sealing of joints or a PVC liner of adequate thickness attached to the planter walls.

Alternatively, to encourage vertical percolation into the subgrade rather than lateral percolation into the wall of an



## 2.SITE-SCALE GREEN INFRASTRUCTURE PRACTICE, SELECTION, DESIGN & MAINTENANCE

excavation, a curtain liner can be used as shown in the tree trench detail. Curtain liners are placed vertically on one or more walls to allow infiltration into the subgrade and limited lateral percolation toward a building. Curtain liners should be used for all facilities within 15 feet of a building that has a basement. When a full liner is recommended by the geotechnical engineer, it is important to specify installation requirements including thermal welding and testing of all seams. It should be noted that most of the design details in this manual do not include a full liner. Refer to the USDCM Vol. 3 for additional details and guidance regarding the installation of full liners.





## 2.SITE-SCALE GREEN INFRASTRUCTURE PRACTICE, SELECTION, DESIGN & MAINTENANCE

TABLE 2: Material Specification for Bioretention/Rain Garden Facilities

Material		Specification		Submittals	Testing	Notes
Bioretention Growing Media (soil + organics)	Bioretention soil	Particle size distribution (by weight): 80-90% sand (0.05 - 2.0 mm diameter) 3-14% silt (0.002-0.5 mm diameter) 3-14% clay (<0.002 diameter) 3 to 5% shredded mulch (see notes) Chemical attribute and nutrient analysis: pH 6.8 - 7.5 organic matter < 1.5% nitrogen <15 ppm phosphorus < 15 ppm salinity < 6 mmhos/cm		Particle size distribution and nutrient analysis required.		Shredded mulch shall be aged 6 months (minimum) and uniformly mixed into media.
Landscape mulch (where applicable)		Shredded mulch				Aged 6 months (minimum). No weed fabric allowed.
Underdrain aggregate	CDOT filter material (Class B or C as specified)		Class B	Class C	Particle size distribution required.	
		37.5 mm (1.5")	100			
		19.0 mm (0.75")		100		
		4.75 mm (No.4)	20-60	60-100		
		1.18 um (No. 16)	10-30			
		300 um (No. 50)	0-10	10-30		
		150 um (No. 100)		0-10		
75 um (No. 200)	0-3	0-3				
Underdrain Pipe	Pipe diameter and type	Maximum slot width (inches)	Minimum open area (per foot)	Required	Pipe must conform to requirements of ASTM designation F949. There shall be no evidence of splitting, cracking, or breaking when the pipe is tested per ASTM test method D2412 in accordance with F949 section 7.5 and ASTM F794	Contech A-2000 slotted pipe (or equal)
	4-inch slotted PVC	0.032	1.90 in. <sup>2</sup>			
	6-inch slotted PVC	0.032	1.98 in. <sup>2</sup>			
Impermeable liner	Thickness	0.76 mm (30 mil)	Test method	Required	Thermal welding required for fully lined facilities (not a cutain). Leak testing in the field required.	
	Thickness, % Tolerance	+/-5	ASTM D 1593			
	Tensile strength, kN/m (lb/in)	12.25 (70)	ASTM D8 82, method B			
	Modulus at 100% elongation, kN/m (lbs/in)	5.25 (30)	ASTM D8 82, method B			
	Ultimate elongation, %	350	ASTM D8 82, method A			
	Tear resistance, N(lbs)	38 (8.5)	ASTM D 1004			
	Low temperature impact, ° C (° F)	-29 (-20)	ASTM D 1790			
	Volatile loss, % maximum	0.7	ASTM D8 82, method A			
	Pinholes, no. per 8 m <sup>2</sup> (no. per 10 yd. <sup>2</sup> )	1 (max)	N/A			
Bonded seam strength, % of tensile strength	80	N/A				

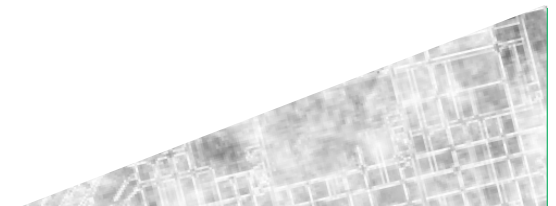

## 2.SITE-SCALE GREEN INFRASTRUCTURE PRACTICE, SELECTION, DESIGN & MAINTENANCE

### 2.2.4 VEGETATION

Vegetation is a key component of green infrastructure BMPs. Plants improve infiltration rates, provide water and nutrient uptake through plant roots, and generally improve water quality through biological processes. Plant species selection and planting design for the planters is a critical design consideration that can greatly affect the overall success and public acceptance of these BMPs within the public right-of-way. Growing conditions in planters in ultra-urban environments are often harsh, so plant selection is important. In general, plants for use in planters should be:

- Drought tolerant;
- Flood/inundation tolerant;
- Mid-sized (taller than 12 inches, lower than 4 feet);
- Upright in form;
- Salt tolerant (especially for planters on streets treated with magnesium chloride deicer);
- Able to thrive in low-fertility, sandy soils (no fertilizer or supplemental compost allowed in planters); and
- Non-invasive.

In addition, ideal plant material should be native, have long flowering periods (if applicable), be attractive year-round, be long-lived (5 to 10 years), and be an aggressive grower.

### PLANT CONSIDERATIONS

Each fact sheet provides planting recommendations and example planting plans. A recommended plant list is included in Appendix C and tree list is included in Appendix D.

- When selecting vegetation, consider the depth of the planter as well as the potential plant height so that plantings do not exceed 42 inches above the sidewalk elevation near intersections to provide required visibility.
- Irrigation is necessary to establish the vegetation and sustain plant health during periods of dry weather.
- All plants should receive approximately 1 inch of moisture (combined rain and irrigation) per week for the first growing season to promote establishment. This requires an automatic irrigation system, or close monitoring by a maintenance staff, an available water source, and hand watering.

- Watering/irrigation of plants after establishment shall be on an as-needed basis. Plants should be monitored a minimum of once every 10 days in the second season, and once every 2 weeks thereafter for watering needs.
- To facilitate ease of maintenance, a neat appearance, and to reduce areas available for weed growth, it is recommended that planting designs employ masses of fairly tightly spaced plantings. Spreading plant materials can be used but require an increased level of maintenance early in the life of the facility so that weeds do not become established.
- Planting beds may be mulched with 1 to 2 inches of shredded wood mulch to reduce weed growth, or left unmulched if plant density is sufficient to cover 75% or more of the bioretention media. The wood mulch should be finely shredded in a manner that creates a fibrous mass that meshes together and resists movement. The thickness of the mulch should be considered part of the bioretention media depth; if 2 inches of mulch are used, the actual thickness of bioretention media should be adjusted from 18 inches to 16 inches. The top of the mulch layer is considered the bottom of the WQCV.

### VEGETATION MAINTENANCE CONSIDERATIONS

- Inspections for sufficient moisture will be required as needed throughout the growing season (March through October).
- Inspections should also consider limitations with regard to the height of vegetation above the sidewalk elevation as it relates to visibility.
- All plantings require monthly inspection during the growing season to ward off infestations of deep rooted perennial weeds such as smooth brome, Russian thistle, leafy spurge, bindweed, and bluegrass.
- Prolific seeding weeds such as cheatgrass, dandelions, prickly lettuce, spotted spurge, purslane, black medic, alfalfa, yellow and white sweet clover also require monthly policing to prevent them from going to seed and creating long term infestations. Horticultural personnel taking care of these gardens will need to be professionals highly familiar with weed species, able to recognize them as seedlings

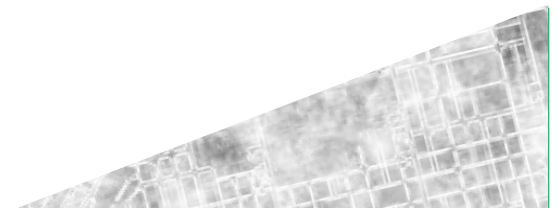

## 2.SITE-SCALE GREEN INFRASTRUCTURE PRACTICE, SELECTION, DESIGN & MAINTENANCE

to ward off infestation. In most instances weeds will need to be extracted and physically removed from the site, not sprayed or pulled and left to wither (and scatter seeds).

- In addition to weed management, planters will require removal of leafy debris each fall (October) and cutting back of perennials and grasses in late winter/early spring (March).

### TREE SPECIES AND PLACEMENT

Trees are encouraged and can be included in Streetside Stormwater Planters, Bumpouts, and Tree Trenches. All tree species planted in Denver street rights-of-way must be approved by the City Forester. A list of recommended species is included in Appendix D. Trees are typically centered in the amenity zone between the step-out zone and the sidewalk. Consideration needs to be given to width requirements for the sidewalk when placing trees. Per City Forester, trees may only be placed in areas with a minimum width of 5 feet. In general, it is recommended that trees be placed 4 to 6 feet from the back of curb. Tree spacing along the street is discussed further in the Tree Trench Fact Sheet.

### 2.3 DESIGNING FOR MAINTENANCE

All of the BMPs in this manual have been designed with consideration for maintenance. Sediment collection pads and forebays have been included to facilitate proactive and routine maintenance. These types of treatment facilities allow for routine maintenance to be done frequently and by personnel with limited expertise in green infrastructure



FIGURE 5. Back side of forebay  
(Source: UCFCF. 2015)

BMPs. Ideally, sediment and debris is removed from sediment collection pads prior to entering the vegetated area. Removal of sediment from the vegetated area is much more disruptive and may require replacement of vegetation.

In some areas, additional consideration to facilitate maintenance may be achieved. Denver has success with forebays that can be maintained as part of the street sweeping program.

Forebays that can be cleaned as part of the street sweeping program require a depression at the location of the BMP. This will ensure capture of the volume to be treated while slowing entry into the vegetated portion. This concept is effective by restricting entry and forcing some sedimentation to occur in the forebay area. This can be achieved by using a curb with several small orifices as shown in Figure 5 rather than one large inlet opening. When located on a street sweeping route, this will ensure routine removal of sediment and debris from the forebay. See Appendix B for maintenance and operation checklists relevant to the BMPs included in this manual.

### 2.4 ACCOMMODATING UTILITIES

Utility conflicts may be the greatest physical constraint for implementation of ultra-urban green infrastructure. Proper investigation of utilities during the planning and design phase can save both time and money in construction. In addition to locating and accommodating existing utilities, the design of green infrastructure facilities must also consider future repair and replacement of all utilities in the area. It

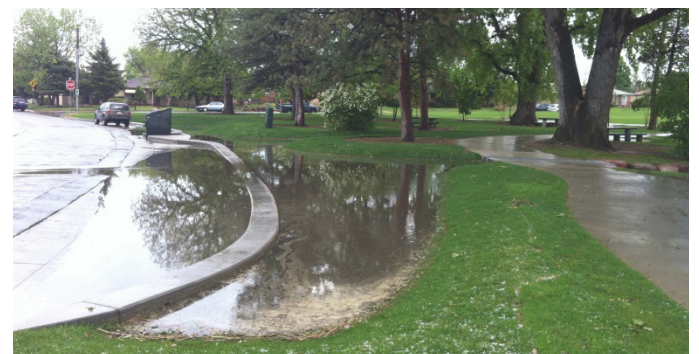
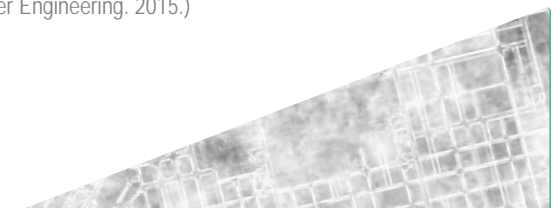

FIGURE 6. Failing stormwater system  
(Source: Muller Engineering. 2015.)



## 2.SITE-SCALE GREEN INFRASTRUCTURE PRACTICE, SELECTION, DESIGN & MAINTENANCE

should be determined during the planning and design phase what party is responsible for repairing damage to the green infrastructure facility during maintenance on other utilities.

Denver has adopted a 4-step approach to accommodating utilities. This approach begins with solutions that are both cost-effective and easily implemented. As the steps progress, solutions become both more costly and more difficult to implement. This approach was adapted from the San Mateo County Sustainable Green Streets and Parking Lots Guidebook (San Mateo, 2009).

### 4-Step Approach for Accommodating Utilities:

#### Step 1: Avoidance

Where possible, locate green infrastructure facilities clear of all utility conflicts. This may dictate the type of green infrastructure design strategy due to space limitations and could require an approach that is more expensive in an effort to avoid utilities. Avoidance can also mean a change in the facilities' dimensions in order to provide adequate setback from existing utilities.

#### Step 2: Acceptance

Green infrastructure facilities may conflict with existing utility locations, but involved entities accept that utility constraints do not preclude the green infrastructure facility from being built. This requires consensus from involved entities that the design provides acceptable clearance between the facility and a utility line and that if a utility line needs to be accessed, it will be acceptable for the green infrastructure facility to be temporarily impacted and then restored to its original condition.

#### Step 3: Mitigation

Green infrastructure facilities are allowed to coexist near a particular utility, but the original design or layout of the green infrastructure facility is adjusted in order to mitigate any concerns about the proximity to the utility. A green infrastructure facility design may need to be significantly altered to provide enough separation or cover over a utility line. Key features of the facility may also need to be moved to avoid conflict. These facilities will be reviewed by Denver on a case-by-case basis.

#### Step 4: Replacement

In order to have the green infrastructure facility work, the utility lines must be replaced and/or relocated. This is the most complex, cost-prohibitive and difficult design option to implement. However, in some cases, the age or pipe material of the utility line is a factor in selecting the solution. It might be more advantageous to plan on replacing an aging utility line during water quality improvements than to wait and replace it at a later date.

#### Potential Utility Conflicts

- Water mains and services
- Gas lines
- Underground power lines
- Above ground power and telephone poles
- Light poles and street signals
- Fiber optic and telecommunication cables
- Steam lines
- Valves and vaults for assorted utilities

### 2.4.1 WATER SERVICES

Due to a number of requirements outlined in the Denver Water standard details for service lines, Denver recommends that stormwater planters and tree pits/tree trenches not be placed over water services if feasible. However, service lines 2.5 inches and under may be allowed under certain conditions. The following limitations and requirements should be considered when placing green infrastructure planters and tree pit/tree trenches:

- Meters cannot be placed in the designated pedestrian sidewalk area or within the planter, but may be placed between the curb and the planter.
- Since required offsets for the curb stop and meter exceed the minimum step-out zone widths (with and without parking), the step-out zone needs to be widened to accommodate the meter. This may require moving the whole planter further from the curb or aligning the sidewalk to avoid the meter.
- Service lines 2.5 inches and under must be sleeved per Denver Water specifications.



## 2.SITE-SCALE GREEN INFRASTRUCTURE PRACTICE, SELECTION, DESIGN & MAINTENANCE

- Service lines 3 inches and over may not be placed under streetside or bumpout stormwater planters or tree pits/tree
- All new taps and modified services require approval and inspection by Denver Water.

Water service lines of any size may be placed under green gutters where the width of the green gutter does not exceed 3 feet. Sleeves are not required in this scenario.

### 2.5 MAINTENANCE RESPONSIBILITY

In order for ultra-urban green infrastructure practices to be effective, proper maintenance is necessary. Maintenance needs should be considered and addressed during the design phase. The maintenance program begins as soon as construction is complete. Routine maintenance, such as sediment and trash removal and weed control, occurs at regular intervals throughout the year. There will also be maintenance activities that are determined based on inspection, such as plant replacement and erosion repair. Restorative maintenance activities include structural repair, filter media replacement, or other significant repairs which should only happen near the end of the expected life of the facility. Maintenance activities will vary from site to site and are dependent on site specific factors such as runoff volume and pollutant loads (sediment, litter), seasonal variations, and adjacent land uses.

### RESPONSIBILITY

There are a number of scenarios in which ultra-urban green infrastructure practices can be used in Denver. These include Denver sponsored construction projects (public) and on private development projects (private). It is important to identify maintenance responsibility early in the design phase. An operations and maintenance plan must be approved prior to project approval.

1. Public Projects: Denver will be responsible for the 'hard' infrastructure associated with green infrastructure facilities in the right-of-way which is often considered the minor and major maintenance activities. This includes repair or

replacement of planter walls, joints between sidewalk and walls, sidewalk drains, inlets, sediment collection pads, water control structures (i.e., cleanouts, underdrains, PVC pipes tied to storm drain system), tree trench forebays, and replacement of the media. The adjacent property owners will be responsible for the 'soft' infrastructure or more routine maintenance activities. This includes removal of trash and debris to minimize clogging of the system and media. It also includes maintenance of vegetation (i.e., trees, shrubs, and perennials) and the irrigation system. Most common vegetation practices will include pruning, weeding, redistribution of mulch/ media after a rain event, and watering during dry periods. Ensuring long-term maintenance of the soft infrastructure will likely require a mechanism, such as the establishment of a business or maintenance improvement district, be put in place. The contractor who installs the facility will be responsible for the warranty period as stated in the construction contract.

2. Private Projects: Private development assumes all maintenance responsibility for green infrastructure assets on private property. City inspectors will ensure projects are completed per plans and inspect yearly to ensure facilities that are built to meet permit requirements and are functioning properly.

### 2.6 CONSTRUCTION OBSERVATION

Construction observation and coordination with the contractor by the designer and owner is recommended to ensure the functionality of all green infrastructure BMPs. Construction observation is recommended to ensure that the following steps are performed in accordance with the design plans:

#### A. Up-front work

- preparing, submitting for review, and revising materials and equipment submittals to secure approvals
- obtaining required permits and approvals
- surveying in the field the location of the green infrastructure BMP

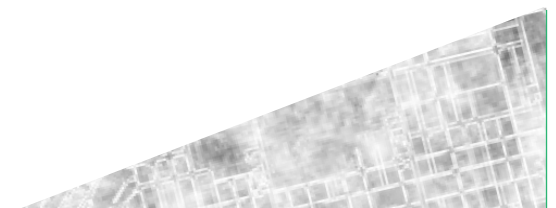

## 2.SITE-SCALE GREEN INFRASTRUCTURE PRACTICE, SELECTION, DESIGN & MAINTENANCE

- locating utilities
- defining construction limits and storage/stockpile areas
- setting up pedestrian and traffic control
- implementing measures to control erosion and sedimentation

### B. Excavation and preparation of subgrade

- demolition of existing sidewalk or pavement
- relocating utilities as necessary
- excavating-stockpiling and removing excess excavated material from site
- ensuring specified compaction of subgrade material

### C. Installation of underdrain tie-in pipelines, water supply pipelines, and electrical

- laying out horizontal alignments and vertical grade of pipeline leading from green infrastructure BMP underdrain outlet to downstream outfalls or tie-in points and water supply pipeline/electrical for irrigation system (if used)
- excavation, placement of bedding, installation of pipe, joints, fittings, and tie-ins
- placement and compaction of backfill

### D. Construction of walls and inlets

- placing formwork, reinforcing steel, and concrete, curing and finishing concrete (for cast-in-place walls, if applicable)
- placing masonry block or brick and mortar (for masonry walls, if applicable)
- placing and fastening wall units (for precast walls, if applicable)
- placing and compacting backfill material outside walls
- forming, placing steel, and concrete placement and
- finishing for inlet (if applicable)
- installing inlet grate or plate (if applicable)
- installing PICP
- placing and finishing concrete flatwork for stepout/splash
- zone and sidewalk adjacent to BMP (where applicable), constructing pavement adjacent green infrastructure BMP
- (where applicable) and constructing concrete and/

or pavement over pipeline leading from underdrain to downstream outfall location

### E. Placement of underdrain, flow control structure (if applicable), and filter

- placing specified thickness of filter material in bottom of BMP
- installing underdrain pipeline, joints, fittings, cleanouts, and connection to downstream outlet pipeline
- installing flow control structure, including drilling or cutting in control orifice and setting weir at specified elevation

### F. Provision and placement of planting media (where applicable)

- providing specified mix of planting media, including amendments
- placing planting media and watering to consolidate to design thickness
- placing sedimentation pad

### G. Provision and placement of permeable pavement section (where applicable)

- providing specified aggregate layers under pavers
- placing concrete edgers
- placing permeable pavers

### H. Provision and placement of structural media

- providing specified mix of bioretention media, including amendments
- mixing structural media
- placing structural media and watering in to consolidate to design thickness
- placing upper layer materials

### I. Installation of irrigation system and seeding/planting

- installing irrigation system and connecting to water supply line
- completing electrical/control for irrigation system
- seeding and planting of specified vegetation

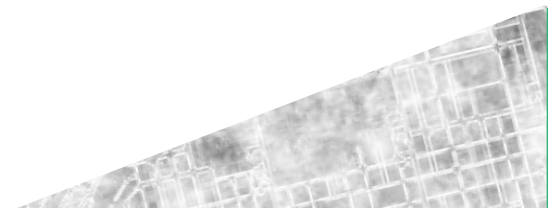

### 3. REFERENCES

Urban Drainage and Flood Control District (2011). Hydraulic Efficiency of Street Inlets Common to UDFCD Region. Denver, Colorado.

Urban Drainage and Flood Control District (2010). Urban Storm Drainage Criteria Manual, Vol. 3, Water Resources Publications, Colorado.

San Mateo Countywide Water Pollution Prevention Program (2009). San Mateo County Sustainable Green Streets and Parking Lots Design Guidebook. San Mateo, California.

Water Environment Foundation Stormwater Report (2014) Colorado's "Taupe Infrastructure".

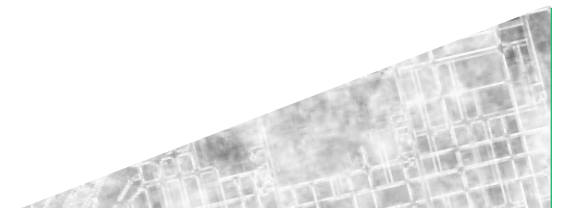

# 4. STREETSIDE STORMWATER PLANTER

## 4.1 DESCRIPTION

A streetside stormwater planter is a type of bioretention facility located within the street right-of-way (ROW) in the amenity zone between the street and the sidewalk. A streetside stormwater planter is intended to provide water quality treatment of runoff from the street and adjacent pedestrian zone and may also be designed to treat runoff from adjacent private development. Stormwater runoff enters the streetside planter through a curb opening and chase type inlet, spreads over the planting media, infiltrates vertically downward, and exits through an underdrain. Treatment processes include filtration, absorption and adsorption, and plant uptake. A variety of vegetation can be established in streetside stormwater planters including grasses, perennials, shrubs, and a limited number of trees.

Except as noted, a streetside stormwater planter follows the design guidance provided in the Bioretention Fact Sheet in Urban Drainage and Flood Control District's (UDFCD) Urban Storm Drainage Criteria Manual, Volume 3 (USDCM Vol. 3). This fact sheet provides specific design guidance for the application of bioretention to a streetside stormwater planter. Detailed drawings and notes are provided at the end of this fact sheet to further illustrate the design of streetside stormwater planters.

Figure 7 illustrates how a streetside stormwater planter can be integrated into the amenity zone of a typical street section. The figure shows the basic elements of the planter in cross section and in perspective. Figure 8 represents an isometric diagram of a streetside stormwater planter.

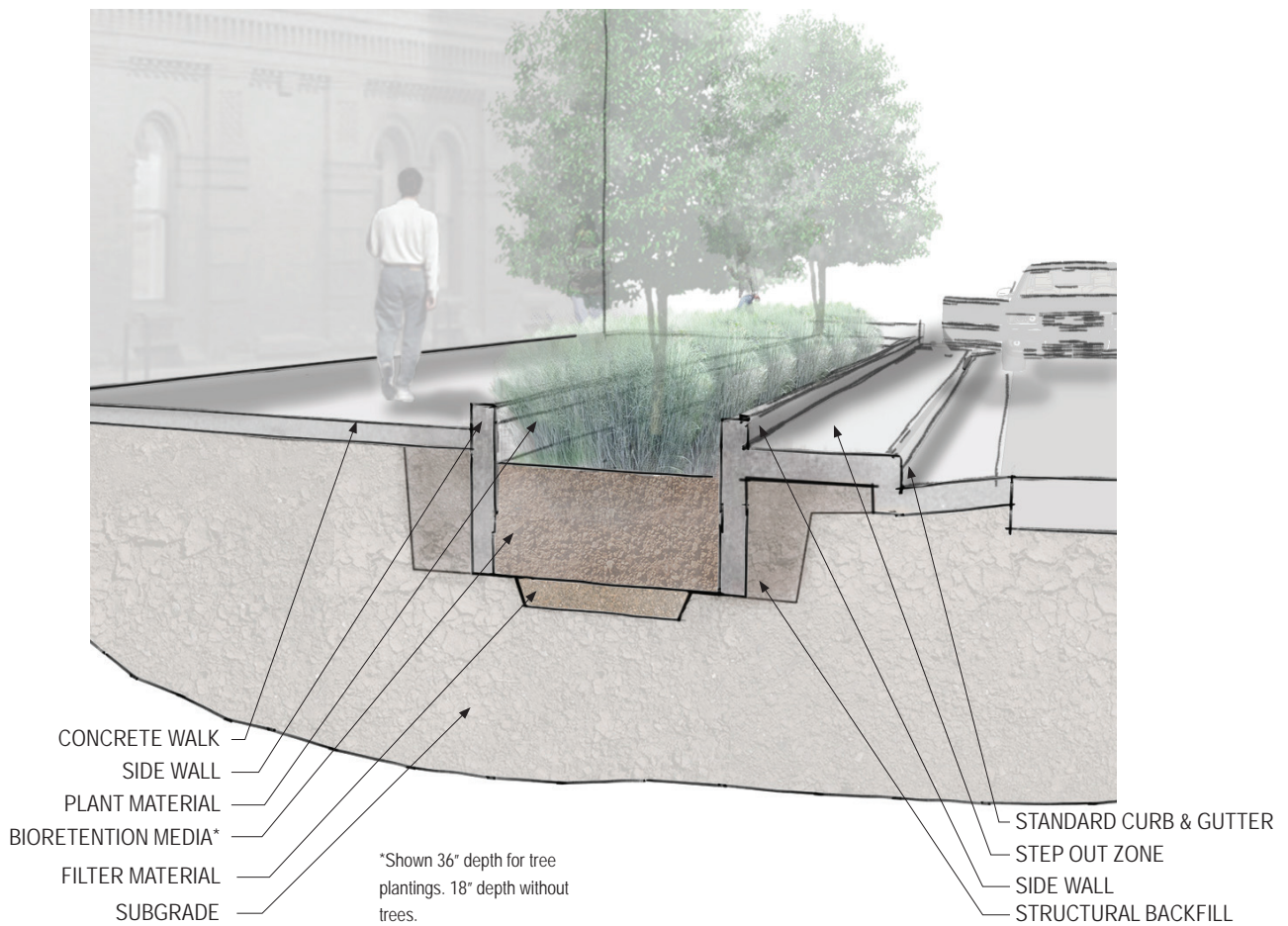

FIGURE 7: Streetside Stormwater Planter  
(Source: Stream Design. 2015.)





## 4. STREETSIDE STORMWATER PLANTER

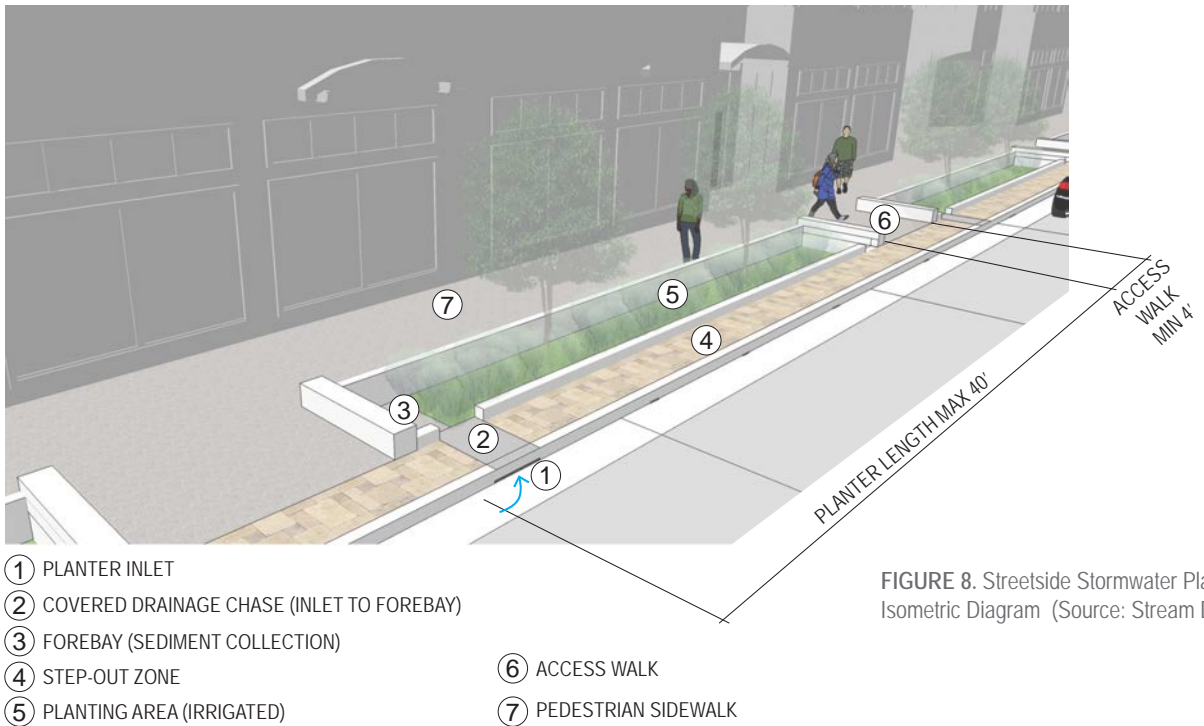

FIGURE 8. Streetside Stormwater Planter Isometric Diagram (Source: Stream Design.2015.)

### 4.2 USES AND RECOMMENDATIONS

Streetside stormwater planters can be created in mid-block locations or near corners on streets that do not receive a deleterious amount of deicing salts. Sizing and locating planters requires a determination of the area draining to the planter. There is a specific drainage area associated with a certain size of planter and it is necessary to place the planter in a location that has this upstream area draining to it. As such, the upstream end of a block is generally not an effective place to install a planter, while mid-block or the downstream end of a block is usually conducive. Adjustments can be made to locations and planter sizes to arrive at a properly sized facility in a desirable location. Siting streetside stormwater planters is also influenced by the presence of a storm drain system; ideally, a nearby inlet or manhole provides a convenient location in which to discharge a planter underdrain. If serving just the public right-of-way (ROW; the street and pedestrian zone), three to four streetside stormwater planters measuring 6 by 40 feet (outside dimensions) can satisfy the water quality requirements for an impervious area measuring 420 feet (a

typical city block) by 30 to 34 feet (street crown to ROW) for Denver's local and collector street classifications. Five to seven streetside stormwater planters this size would be necessary to serve the water quality needs of a city block (crown to ROW) of Denver's four lane and six lane arterial classifications. If a portion of the adjacent private development is also served, additional planters would be necessary. If the planter length was limited based on steeper street slope to less than 40 feet, a greater number of planters would be necessary.

Figure 9 illustrates the layout of streetside stormwater planters measuring 6 by 40 feet (outside dimensions) for the drainage area shown in orange. This is based on a street crown to ROW distance of 40 feet.

Streetside stormwater planters can be implemented in various combinations with the other types of green infrastructure described in these fact sheets. Table 1 in the Introduction provides information on approximate drainage areas that can be treated by various types of green infrastructure BMPs.



## 4. STREETSIDE STORMWATER PLANTER

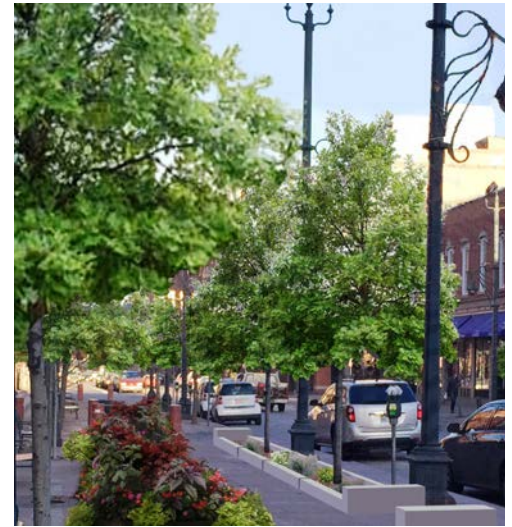
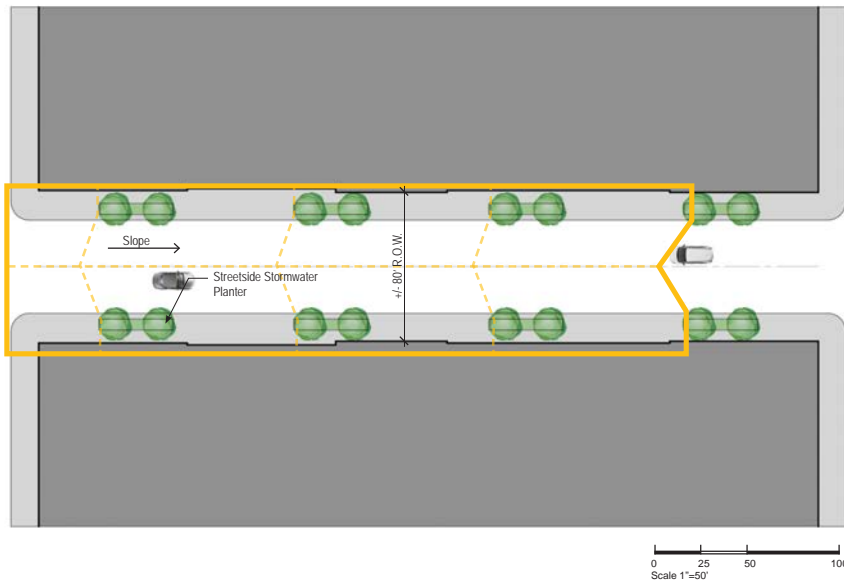

FIGURE 10. Streetside Stormwater in Urban Landscape (Source: Tetra Tech.2015.)

### 4.3 PLANTER AESTHETICS AND URBAN DESIGN

Streetside stormwater planters can be valuable amenities to the urban landscape if designed properly. Designers should take design cues from the surrounding streetscape (if improved) and/or special district urban design elements and materials. Planters should match or complement the larger urban context, as well as add value to the adjacent properties. Since planters are located within the public right-of-way, it is imperative that the design detailing for the planters is uniform within each block and preferably within each district or neighborhood. Figure 10 illustrates how streetside stormwater planters can be integrated into the urban landscape. Pedestrian access and safety considerations are discussed in the Design Criteria section of the Introduction. Use of sidewalks and end walls are recommended to discourage the deliberate or inadvertent entry by pedestrians, because the top of the planting media in the planters is depressed below the elevation of the sidewalk. While concrete curbs and walls and standard steel railings are part of a typical design palette, designers may explore the use of other materials, such as stone, railings, etc. All designs should comply with the City of Denver Streetscape Design

Manual as well as the Public Works Transportation Standards and Details. In the event of conflicting criteria, these criteria supersede when constructing BMPs included in this manual.

### 4.4 GEOMETRY

The conceptual design details included in this fact sheet illustrate the geometry and design features of a streetside stormwater planter. The details are intended to provide a basis for the designer's final construction documents, although a site-specific design will be necessary addressing geotechnical issues, structural design, utility protection and relocation, tying in underdrain to a downstream storm drain or outfall, irrigation design, vegetation plan, and associated final design and construction document preparation tasks.

### WIDTH

Normally, planters should be made as wide as possible within the available ROW based on desired widths of the step-out zone and sidewalk. Although these dimensions may vary, especially in older built-out areas, a typical width for a streetside stormwater planter with a stepout zone of 2.5 feet is six feet. Planters that have a minimum inside width of 5 feet can



## 4. STREETSIDE STORMWATER PLANTER

incorporate trees. For situations where less ROW is available, the width may need to be reduced; however, there is a practical minimum below which it may not make sense to incorporate a streetside stormwater planter.

### LENGTH

Section 2.2 Design Criteria (page 4) provides a discussion of design considerations associated with planter length. Those considerations translate into a typical range of lengths from about 20 feet to a maximum of 40 feet with adjacent access points on the ends at least four feet wide.

### PROFILE

As mentioned in Section 2.2 Design Criteria, it is recommended that the top of the bioretention media be horizontal in longitudinal profile and that the top of the side walls be configured to be parallel to the sidewalk at a height of 6 inches or greater, as shown in the details.

If openings in the sidewall along the sidewalk are not used to provide drainage into the planter, the top of the walls can be designed to be horizontal, parallel to the top of the media, for the whole length of the planter. In this case, the water quality water surface can be retained within the planter even with steeper street slopes, as discussed in Section 2.2 Design Criteria of the Introduction.

### 4.5 PLANTER DESIGN CONSIDERATIONS WQCV ZONE

In keeping with USDCM Vol. 3 criteria for bioretention facilities, a water quality capture volume (WQCV) zone is required above the planting media. This zone is measured from the top of the media to the elevation of the flow line at the inlet that controls when water will start to flow out of the planter and down the gutter. Although it is possible to design stormwater planters with a water quality depth as great as 12 inches, from an aesthetic standpoint it is desirable to keep the top of the media as high as possible relative to the adjacent sidewalk

elevation. For this reason, the top of media will typically be set 6 inches to 9 inches below the water quality water surface. The details at the end of this fact sheet illustrate the critical flow line elevation that defines the water quality water surface.

In addition to the surface volume extending from the top of the media up to the water quality water surface, the volume of the pore spaces in the media equivalent to 14 percent of the media and filter material volume can be counted toward the required WQCV in the ultra-urban green infrastructure BMPs documented in this manual. This pore space volume was selected based on testing of media approximately 24 hours after saturation. As stated in Section 2.2 Design Criteria, the required WQCV for the upstream area draining to a streetside stormwater planter shall be computed using the procedures in Volume 3 of the USDCM. It is important to ensure that the area of the filter (the flat surface of the bioretention media) is sized appropriately for the tributary area. The filter area shall be no less than 2 percent of the upstream area draining to the planter.

### INLET AND SEDIMENT COLLECTION PAD

A concrete sediment collection pad is recommended immediately downstream of the inlet to dissipate energy and collect a portion of the sediment and debris entering the planter for subsequent removal during maintenance operations. Additional information on inlet layout and sizing is provided in Section 2.2 Design Criteria.

### OTHER PLANTER COMPONENTS

Section 2.2 Design Criteria provides information regarding the following components of a streetside stormwater planter:

- bioretention media
- underdrain system
- walls
- sidewalk drainage
- spillway
- liner



## 4. STREETSIDE STORMWATER PLANTER

### 4.6 VEGETATION

#### TYPICAL PLANTING PLANS

General information on plant selection, critical success factors for establishment, and maintenance considerations are discussed in Section 2.2 Design Criteria of the Introduction. Typical planting plans specific for a streetside stormwater planter are described in this section. Trees are optional in these planters but may be used to meet tree right-of-way tree requirements where applicable. If trees are utilized the depth of media shall be increased to 36 inches. If trees that create dense shade are utilized, designers may opt to use more shade tolerant grass species. A recommended plant list is provided in Appendix C; a list of suitable trees is provided in Appendix D.

Custom planting designs should be developed for each project. Designs should take into account site characteristics such as shade, urban or residential character, planter size, and above all, anticipated maintenance schedule and responsibilities. Designs should also reflect neighborhood or district-wide planting approaches and plant palettes. Several typical planting plans are provided below. These are intended to provide examples of different planting approaches in a range of styles and maintenance levels. The use of non-plant landscape materials such as stone or boulders is not recommended as it will reduce infiltration. Regardless of the type of planting plan, a zone of dense vegetation is recommended adjacent to the concrete sedimentation pad to help dissipate the energy of incoming flows and promote deposition of sediment and debris on the pad.

### BASIC GRASS COVER

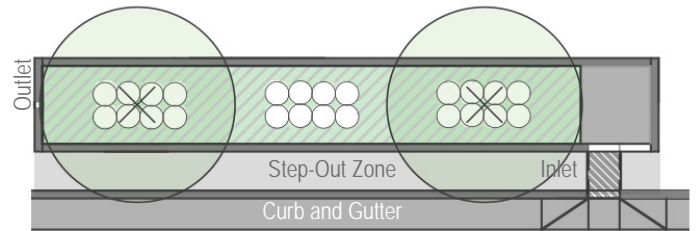

FIGURE 11. Basic Grass Cover Planting Plan (Source: Stream Design. 2015.)  
Scale: 1" = 10'

#### PLANT LEGEND



Native grasses at triangular spacing to uniformly cover and fill the planter area with 6"-18" spacing. Preferred species include:

- *Bouteloua gracilis* 'Blonde Ambition'
- *Deschampsia cespitosa* 'Tufted Hairgrass'
- *Schizachyrium scoparium* 'Prairie Blues'
- *Muhlenbergia reverchonii* 'Undaunted Ruby'
- *Sporobolus heterolepis* 'Prairie Dropseed'



30" - 48" tall accent plant (native grass or approved perennial or shrub)

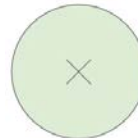

Tree per CCD Forestry recommendation

The Basic Grass Cover plan shown in Figure 11 comprises a relatively simple arrangement of primarily native grasses with some accent plants intended to create essentially full coverage of the bioretention media. The Basic Grass Cover plan is intended to create a "wall-to-wall" planting of low to mid height native and ornamental grasses with variety provided by clusters of taller grasses, perennials or shrubs in the center of the planter. While regular maintenance is required, the simple design of the Grass Cover plan allows easier identification of weeds by maintenance staff.



#### 4. STREETSIDE STORMWATER PLANTER

##### WESTERN PRAIRIE

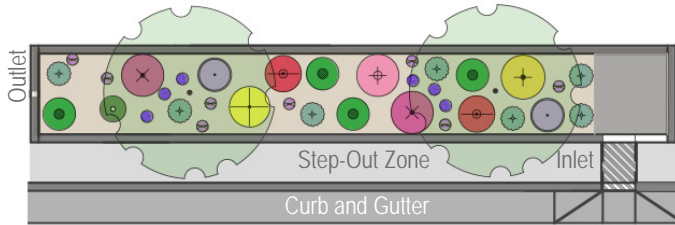







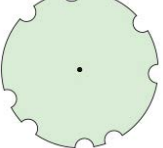







FIGURE 12. Western Prairie Planting Plan (Source: Stream Design. 2015.)  
Scale: 1" = 10'

##### PLANT LEGEND

- |   |   |
|---|---|
|  <i>Andropogon gerardii</i><br>'Windwalker Big Bluestem Grass'   |  <i>Schizachyrium scoparium</i><br>'Prairie Blues'   |
|  <i>Camassia leichtlinii</i><br>'Blue Danube'                    |  <i>Sporobolus heterolepis</i><br>'Prairie Dropseed' |
|  <i>Phlox paniculata</i><br>'David'                              |  <i>Aster laevis</i><br>'Bluebird'                   |
|  <i>Liatris ligulistylis</i><br>'Rocky Mountain Gayfeather'      | <br>Tree per CCD Forestry<br>recommendation         |
|  <i>Monarda fistulosa</i><br>'Eastern Bergamot'                |   |
|  <i>Muhlenbergia reverchonii</i><br>'Undaunted Ruby'           |   |
|  <i>Monarda bradburiana</i><br>'Wild Bergamot'                 |   |
|  <i>Ratibida pinnata</i><br>'Pinnate Prairie Coneflower'       |   |
|  <i>Anaphalis margaritacea</i><br>'Western Pearly Everlasting' |   |

The Western Prairie typical planting plan illustrated in Figure 12 is intended to present an image of a "natural" prairie. Primarily native grasses and herbaceous perennials, this plan is arranged in a naturalistic style that allows for the planting to change with time as certain species thrive and others recede. While all streetside stormwater planters will require a significant amount of maintenance to keep them weed free and healthy, this planting plan can be more forgiving and will require less maintenance than more formal approaches.

#### 4. STREETSIDE STORMWATER PLANTER

##### MODERN MATRIX

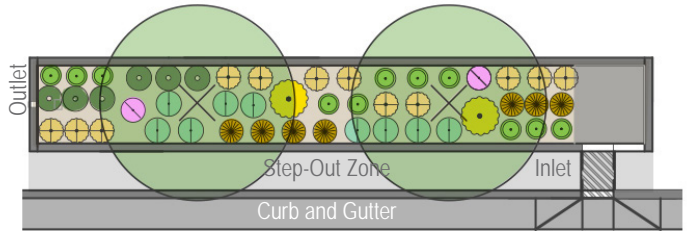



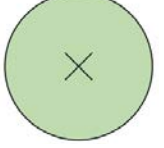









FIGURE 13. Modern Matrix Planting Plan (Source: Stream Design. 2015.)  
Scale: 1" = 10'

##### PLANT LEGEND

- |   |   |
|---|---|
|  <i>Amorpha canescens</i><br>'Leadplant'                       |  <i>Sporobolus heterolepis</i><br>'Prairie Dropseed' |
|  <i>Anaphalis margaritacea</i><br>'Western Pearly Everlasting' | <br>Tree per CCD Forestry<br>recommendation         |
|  <i>Calamagrostis x acutiflora</i><br>'Karl Foerster'          |   |
|  <i>Camassia leichtlinii</i><br>'Blue Danube'                  |   |
|  <i>Liatris ligulistylis</i><br>'Rocky Mountain Gayfeather'  |   |
|  <i>Panicum virgatum</i><br>'Northwind'                      |   |
|  <i>Panicum virgatum</i><br>'Prairie Sky'                    |   |
|  <i>Monarda bradburiana</i><br>'Wild Bergamot'               |   |
|  <i>Helianthus maximiliana</i><br>'Dakota Sunshine'          |   |

The Modern Matrix plan uses drought tolerant native materials and groups them in regular clusters and groupings to create a more organic, urban garden. A typical plan is shown in Figure 13. While individual plant species are chosen for drought tolerance and hardiness, the more ordered approach may require slightly more maintenance to maintain its character and look attractive versus the other approaches illustrated.



## 4.7 STREETSIDE STORMWATER PLANTER DETAILS

A typical design of a streetside stormwater planter is illustrated in a series of detail drawings in this section. The details indicate various elements of the planter and representative dimensions. The designer is responsible for preparing final construction drawings suitable for the specific conditions, water quality requirements, utilities and constraints existing in the location where the BMP is to be sited. A geotechnical engineer shall consult on soil conditions and recommendations for lining. A structural engineer, with input from the geotechnical engineer shall design concrete elements, including wall thickness, reinforcing (reinforcing shown in details is representative only), any foundation components such as footings or bottom slab, and subgrade/bedding/backfill specifications. A site-specific design will also be necessary addressing utility protection and relocation, tying in underdrain to a downstream storm drain or outfall, irrigation design, vegetation plan, and associated final design and construction document preparation tasks.

The following design notes apply to the detail drawings.

## DESIGN NOTES

1. INLET WIDTH VARIES BASED ON UPSTREAM IMPERVIOUS AREA AND STREET SLOPE, WITH A MINIMUM WIDTH OF 2 FEET AND A MAXIMUM WIDTH OF 3 FEET. SEE CRITERIA FOR SIZING INLET WIDTH IN INTRODUCTION SECTION.
2. INLET COVER SHALL MEET ADA ACCESSIBILITY REQUIREMENTS AND AND CONSIST OF NEENAH R-4999 HEAVY DUTY BOLTED TRENCH GRATE TYPE D (SOLID) OR APPROVED EQUIVALENT – CATALOGUE NO. R-4999-HX FOR SPAN OF 2 FEET AND R-4999-MX FOR SPAN OF 3 FEET. THE LENGTH OF THE INLET COVER SHOULD BE FIELD CUT TO EXTEND CONTINUOUSLY FROM THE FACE OF CURB TO BACK OF PLANTER WALL AND SHOULD BE RECESSED FROM THE FACE OF THE CURB SO THAT THE CORNERS OF THE PLATE DO NOT PROTRUDE BEYOND THE TOP OF CURB.
3. STRUCTURAL ENGINEER, WITH INPUT FROM GEOTECHNICAL ENGINEER, SHALL DESIGN WALL DIMENSIONS, REINFORCING, ANY FOUNDATION COMPONENTS SUCH AS FOOTINGS OR BOTTOM SLAB, AND SUBGRADE/BEDDING/BACKFILL SPECIFICATIONS.
4. IN AREAS WHERE PARKING IS ALLOWED, THE MINIMUM STEP-OUT ZONE WIDTH FROM BACK OF CURB TO OUTER WALL OF PLANTER IS 2 FEET 6 INCHES. IN AREAS WHERE PARKING IS NOT ALLOWED, THE MINIMUM RECOMMENDED SPLASH STRIP WIDTH FROM BACK OF CURB TO OUTER WALL OF PLANTER IS 1 FOOT 6 INCHES.
5. FOR STREET SLOPES LESS THAN 5.5 PERCENT, THE ELEVATION OF THE FLOW LINE AT POINT A REPRESENTS THE WATER SURFACE ELEVATION ABOVE WHICH WATER IN THE PLANTER WOULD START TO FLOW OUT AND BE CONVEYED DOWN THE GUTTER. THIS ELEVATION IS EQUAL TO THE WATER QUALITY WATER SURFACE AND IS THE TOP OF THE WATER QUALITY CAPTURE VOLUME (WQCV).
6. FOR STREET SLOPES GREATER THAN 5.5 PERCENT, THE ELEVATION OF THE FLOW LINE AT POINT B REPRESENTS THE WATER SURFACE ELEVATION ABOVE WHICH WATER IN THE PLANTER WOULD START TO FLOW OUT AND BE



## 4. STREETSIDE STORMWATER PLANTER

### DESIGN NOTES

- CONVEYED DOWN THE GUTTER. THIS ELEVATION IS EQUAL TO THE WATER QUALITY WATER SURFACE AND IS THE TOP OF THE WATER QUALITY CAPTURE VOLUME.
7. THE WATER CONTROL STRUCTURE IS COMPRISED OF AN INCLINE WATER LEVEL CONTROL STRUCTURE AS SHOWN IN THE DETAILS. THIS STRUCTURE HOUSES A CONTROL ORIFICE DESIGNED TO RELEASE THE WQCV IN 12 HOURS AND A WEIR SET WITHIN 2 INCHES BELOW TO 2 INCHES ABOVE THE WATER QUALITY WATER SURFACE. THE WATER CONTROL STRUCTURE SHALL BE AN AGRI DRAIN INLINE WATER LEVEL CONTROL STRUCTURE AS MANUFACTURED BY AGRI DRAIN CORPORATION, OR APPROVED EQUIVALENT.
  8. THE UNDERDRAIN SHALL MEET THE MATERIAL AND SLOT SPECIFICATIONS IDENTIFIED IN USDCM VOLUME 3. THE MINIMUM LENGTH OF SLOTTED UNDERDRAIN SHALL BE 4 FEET.
  9. THE WATER QUALITY WATER SURFACE IS THE TOP OF THE WQCV AND IS EQUAL TO THE ELEVATION OF THE FLOW LINE AT POINT A FOR STREET SLOPES LESS THAN 5.5 PERCENT AND AT POINT B FOR STREET SLOPES GREATER THAN 5.5 PERCENT.
  10. BIORETENTION MEDIA SHALL MEET THE SPECIFICATIONS IDENTIFIED IN THE DESIGN CRITERIA SECTION OF THE INTRODUCTION. TOP OF MEDIA SHALL BE PER PLAN AND A MINIMUM OF 6 INCHES AND A MAXIMUM OF 9 INCHES BELOW THE WQCV WATER SURFACE ELEVATION.
  11. FILTER MATERIAL SHALL MEET THE SPECIFICATIONS IDENTIFIED IN USDCM VOLUME 3. FILTER MATERIAL (NOT BIORETENTION MEDIA) SHALL BE COMPACTED TO A DENSITY OF NOT LESS THAN 70 PERCENT OF RELATIVE DENSITY DETERMINED IN ACCORDANCE WITH ASTM D4253 AND D4254 (FOR FINES CONTENT LESS THAN 5 PERCENT).
  12. THE UNDERDRAIN CLEANOUT SHALL CONSIST OF 4 INCH POLYVINYL CHLORIDE (PVC) PIPE WITH TWO 45 DEGREE BENDS AND A THREADED CAP SET 2 INCHES ABOVE THE TOP OF THE BIORETENTION MEDIA.
  13. PROVIDE A GAP IN THE SIDEWALL OR DEPRESSED SECTION (SPILLWAY) AT THE DOWNSTREAM END OF THE STREETSIDE PLANTER WALL AT LEAST 2 FEET LONG TO ENSURE THAT OVERFLOWS FROM PLANTER WILL EXIT ON THE STREETSIDE. THE CREST OF THE SPILLWAY SHALL BE SET AT THE WQCV WATER SURFACE ELEVATION.
  14. STRUCTURAL BACKFILL SHALL CONSIST OF CDOT CLASS 1 OR 2 STRUCTURE BACKFILL, AS DETERMINED BY ENGINEER AND COMPACTED TO AT LEAST 95 PERCENT OF MAXIMUM DENSITY IN ACCORDANCE WITH ASTM D698.



## 4. STREETSIDE STORMWATER PLANTER

FIGURE 14. Streetside Stormwater Planter Details  
 (Source: Muller Engineering, 2015.)

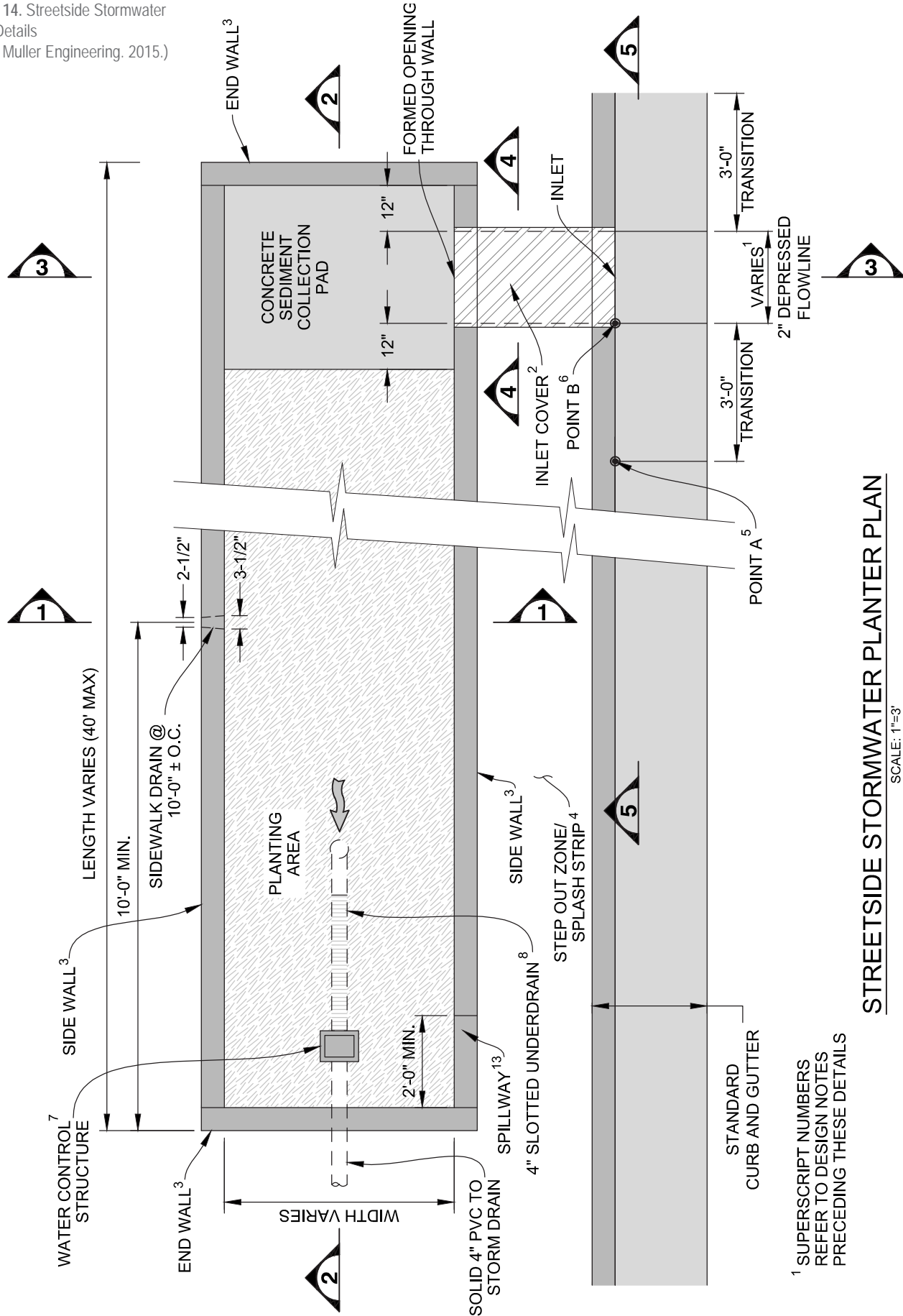

### STREETSIDE STORMWATER PLANTER PLAN

SCALE: 1"=3'

<sup>1</sup> SUPERSCRIPT NUMBERS REFER TO DESIGN NOTES PRECEDING THESE DETAILS





4. STREETSIDE STORMWATER PLANTER

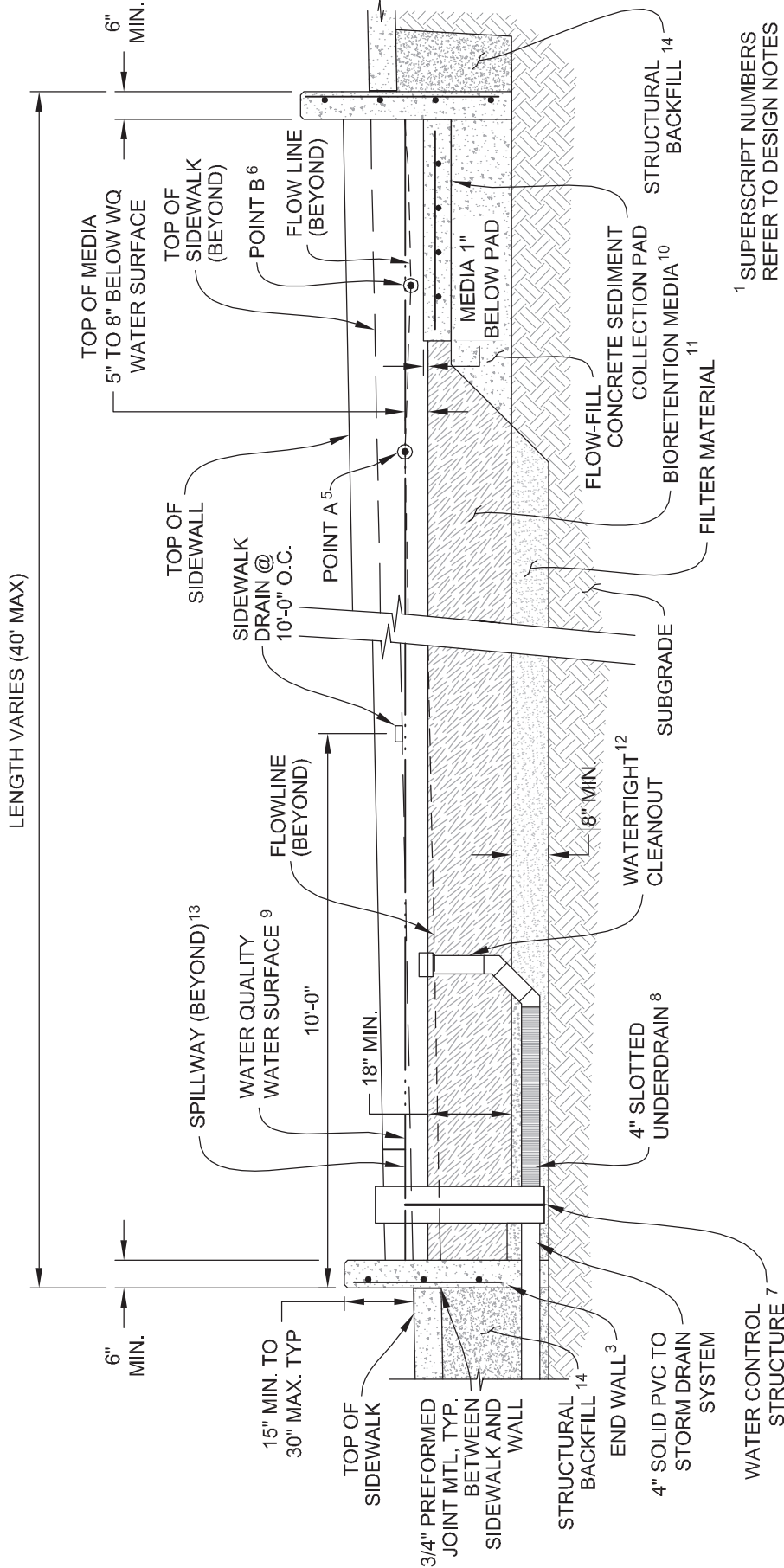

<sup>1</sup> SUPERScript NUMBERS REFER TO DESIGN NOTES PRECEDING THESE DETAILS



**STREETSIDE STORMWATER PLANTER - SECTION 2**

(LONGITUDINAL SLOPE OF 2% SHOWN WITH 40' PLANTER LENGTH)  
SCALE: 1"=3'

4. STREETSIDE STORMWATER PLANTER

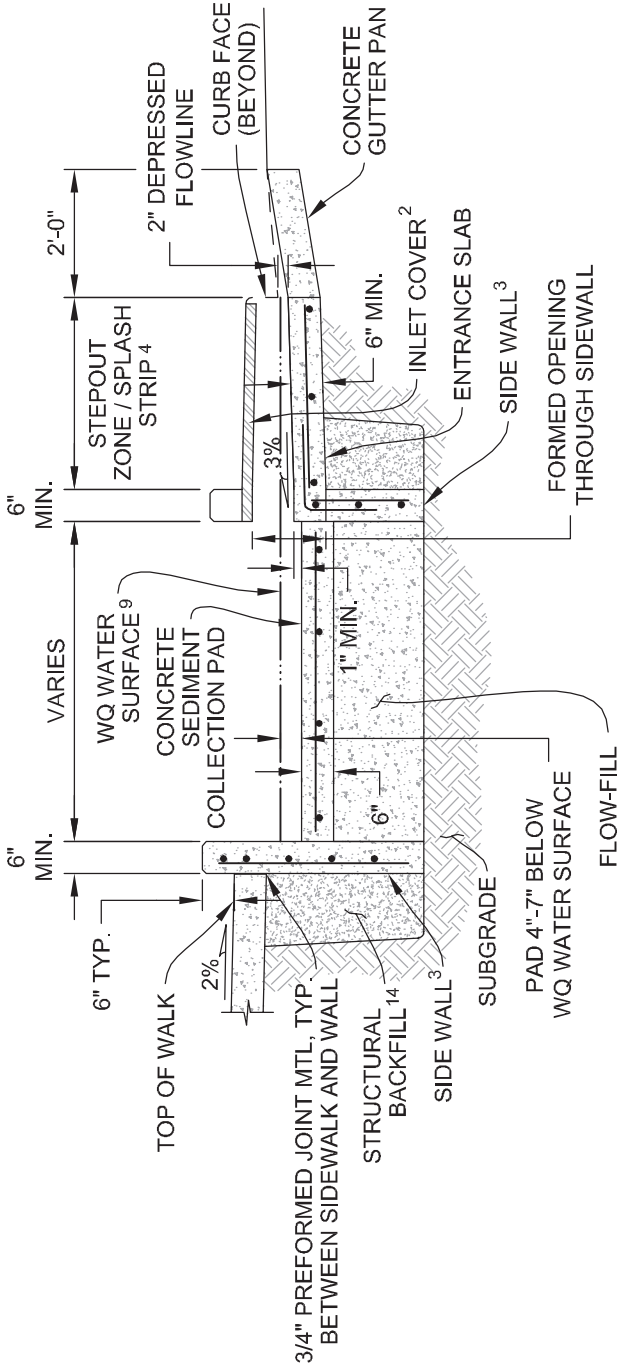

<sup>1</sup> SUPERScript NUMBERS REFER TO DESIGN NOTES PRECEDING THESE DETAILS

**INLET - SECTION 3**

SCALE: 1"=3'

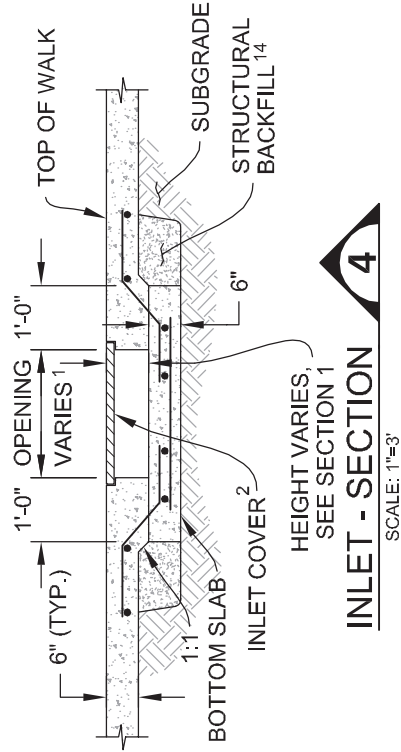

HEIGHT VARIES SEE SECTION 1

**INLET - SECTION 4**

SCALE: 1"=3'

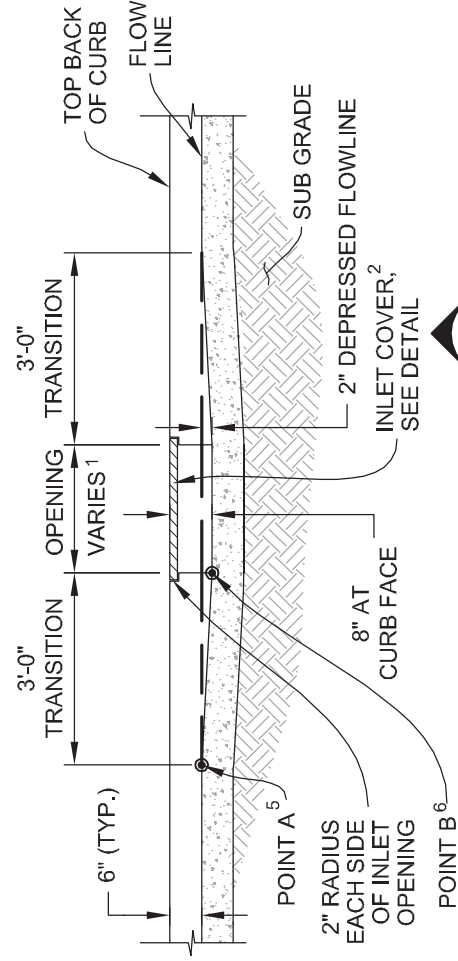

**INLET - SECTION 5**

SCALE: 1"=3'

4. STREETSIDE STORMWATER PLANTER

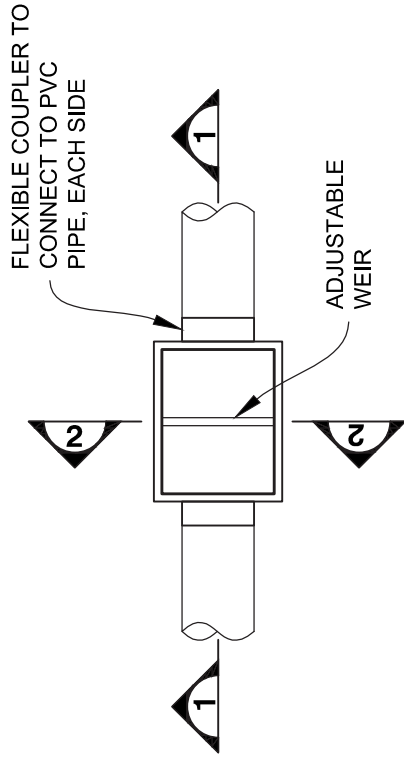

**WATER CONTROL STRUCTURE - PLAN**  
SCALE: 1"=1'

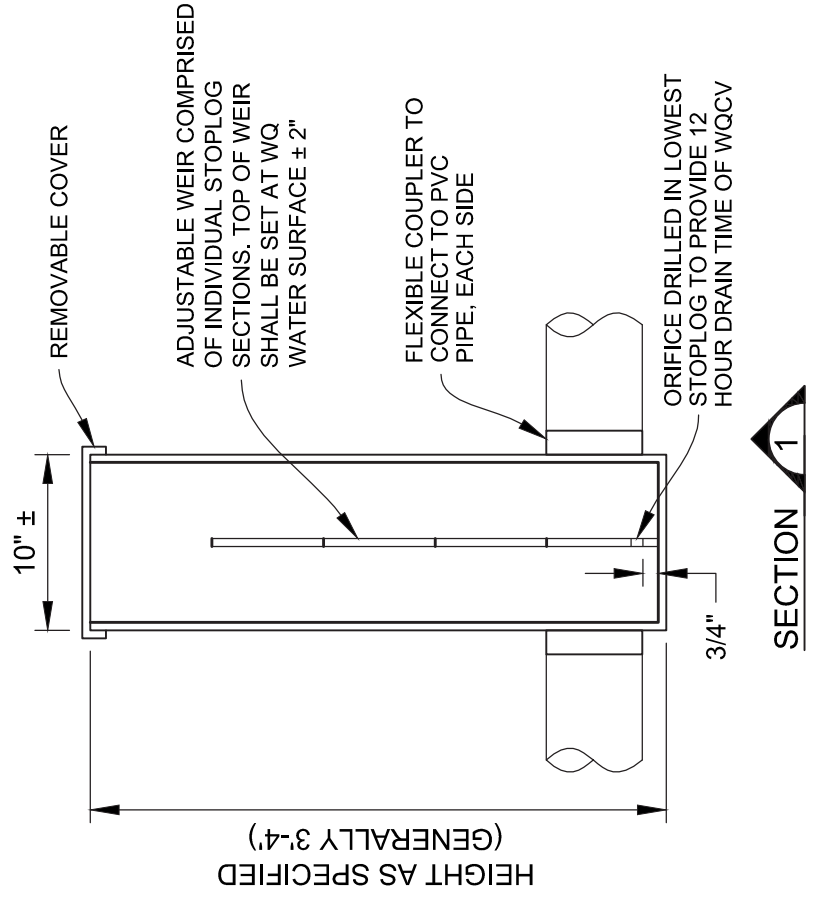
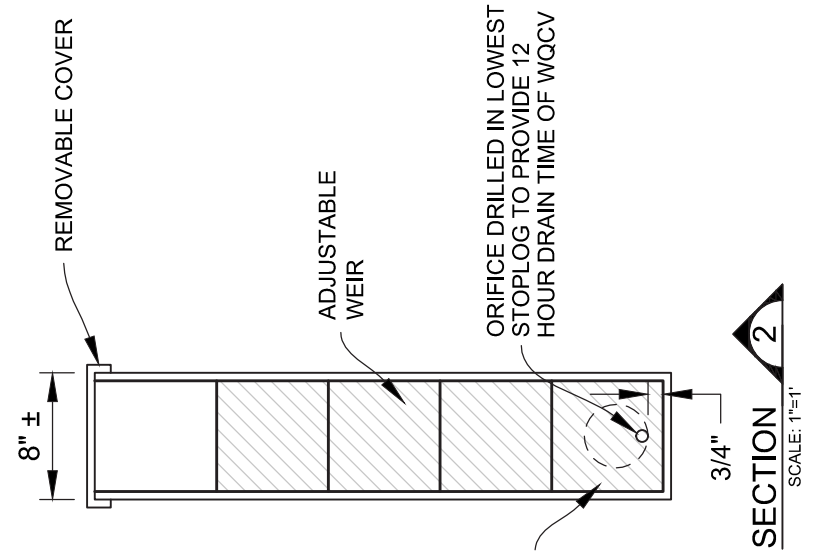

# 5. BUMPOUT STORMWATER PLANTER

## 5.1 DESCRIPTION

A bumpout stormwater planter is a type of bioretention facility located within street right-of-way (ROW) in an enlarged amenity zone between the street and the sidewalk created when the curb and gutter is moved out into the portion of the roadway normally reserved for parking. Bumpouts are becoming more prevalent as a means of calming traffic and providing expanded areas of vegetation and interest within the road ROW. A bumpout stormwater planter is intended to provide water quality treatment of runoff from the street and adjacent pedestrian zone and may also be designed to treat runoff from adjacent private development. Stormwater runoff enters the bumpout planter through a curb opening and chase type inlet, spreads over the planting media, infiltrates vertically downward, and exits through an underdrain.

Treatment processes include filtration, soil adsorption, and plant uptake. A variety of vegetation can be established in bumpout stormwater planters including grasses, flowers, shrubs, and trees. Except as noted, a bumpout stormwater planter follows the design guidance provided in the Bioretention Fact Sheet in Urban Drainage and Flood Control District's (UDFCD) Urban Storm Drainage Criteria Manual, Volume 3 (USDCM Vol. 3) This fact sheet provides specific design guidance for the application of bioretention to a bumpout stormwater planter. Detailed drawings and notes are provided at the back of this fact sheet to further illustrate the design of bumpout stormwater planters. Figure 15 illustrates how a bumpout stormwater planter can be integrated into the amenity zone of a typical street section. The figure shows the basic elements of the planter in cross section and in perspective. Figure 16 provides an isometric view of a bumpout stormwater planter.

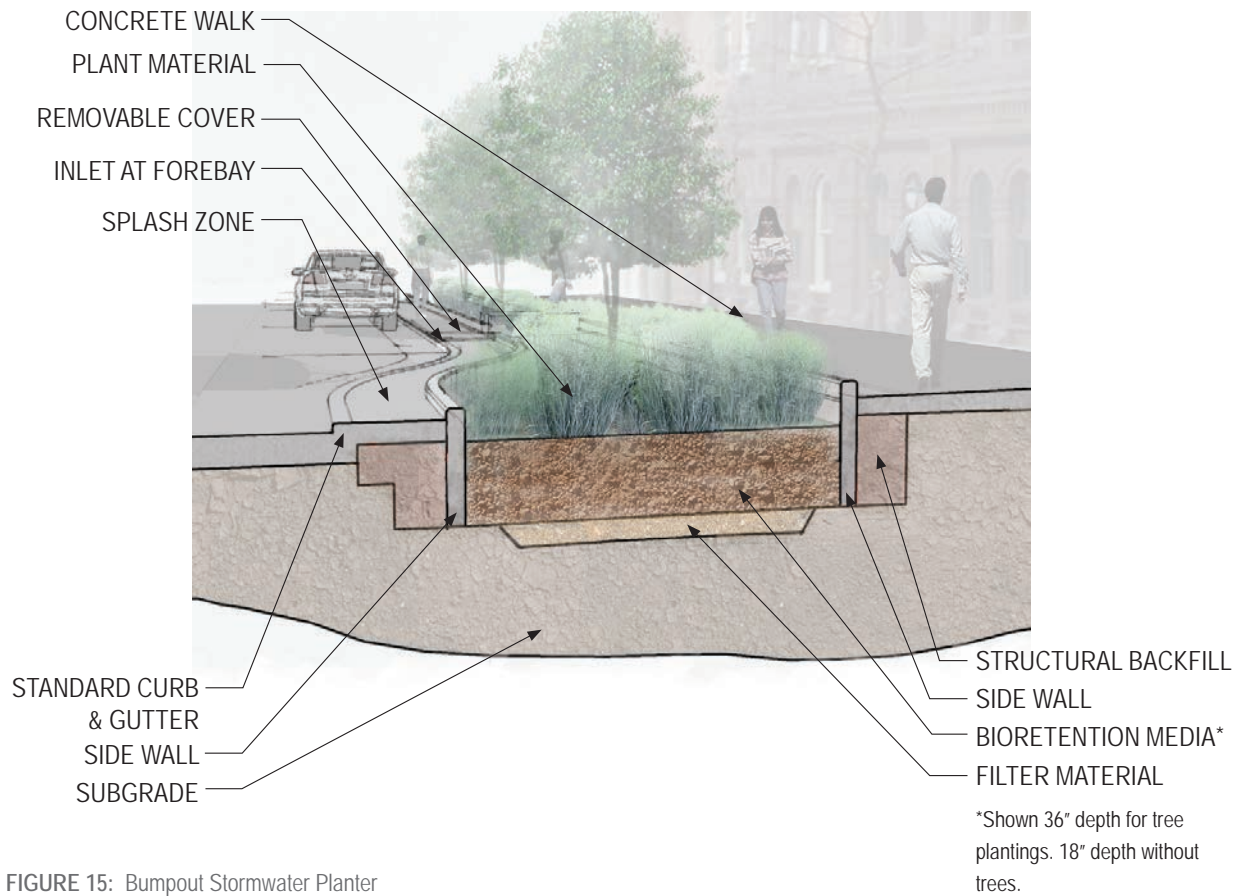

FIGURE 15: Bumpout Stormwater Planter  
(Source: Stream Design. 2015.)



## 5. BUMPOUT STORMWATER PLANTER

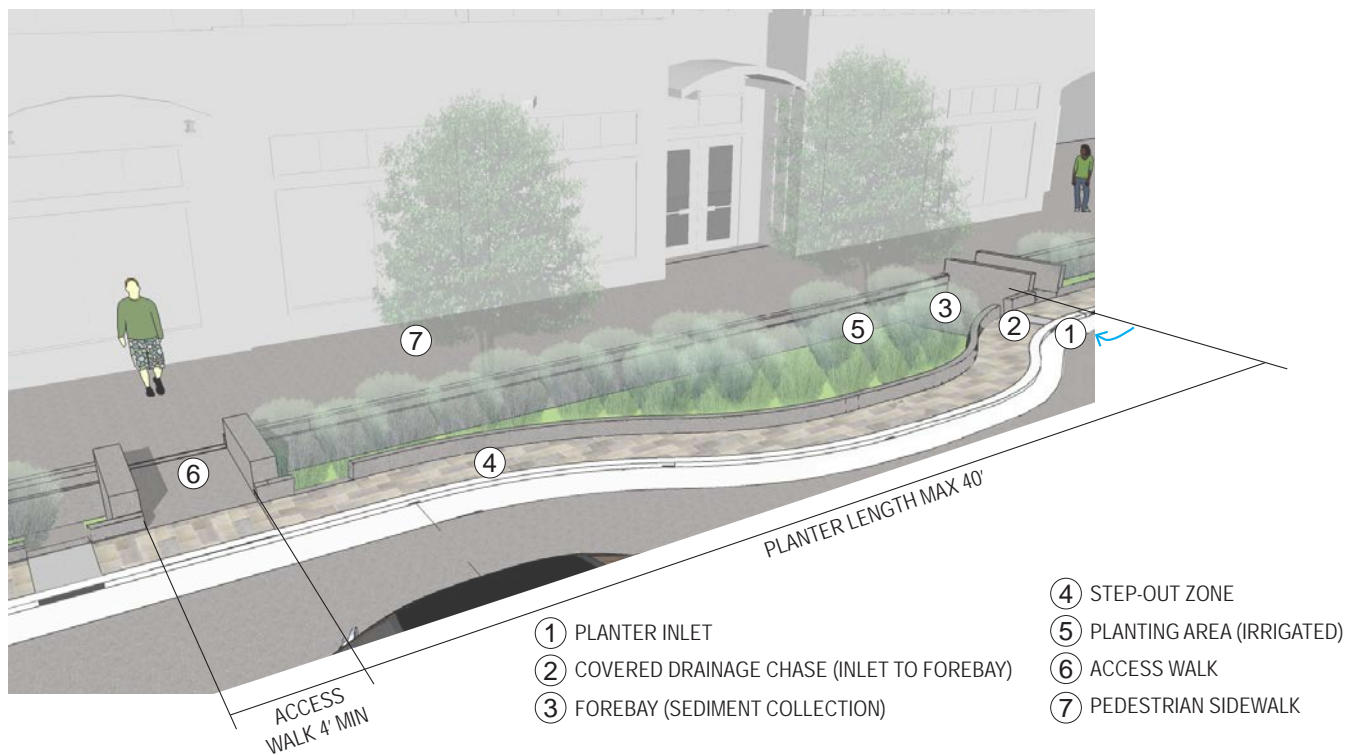

FIGURE 16. Bumpout Stormwater Planter Isometric Diagram (Source: Stream Design. 2015.)

### 5.2 USES AND RECOMMENDATIONS

Bumpout stormwater planters can be created in mid-block locations or near corners on streets that do not receive a deleterious amount of deicing salts. Sizing and locating planters requires a determination of the area draining to the planter. There is a specific drainage area associated with a certain size of planter and it is necessary to place the planter in a location that has this upstream area draining to it. As such, the upstream end of a block is generally not an effective place to install a planter, while mid-block or the downstream end of a block is usually conducive. Adjustments can be made to locations and planter sizes to arrive at a properly sized facility in a desirable location. Siting bumpout stormwater planters is also influenced by the presence of a storm drain system; ideally, a nearby inlet or manhole provides a convenient location in which to discharge a planter underdrain.

A bumpout stormwater planter 40 feet long can provide almost twice the WQCV as a streetside stormwater planter the same

length. Therefore, depending on the width of the street ROW, as few as one corner bumpout planter and one mid-block bumpout planter can satisfy the water quality requirements for a city block from crown to ROW line for Denver's local and collector street classifications. Denver's four and six lane arterial classifications require additional planters, such as two corner and two mid-block bumpouts. If the planter length was limited based on steeper street slope to less than 40 feet, a greater number of planters would be necessary. Figure 17 illustrates the layout of bumpout stormwater planters for the drainage area shown in orange. This is based on a street crown to ROW distance of 40 feet.

Bumpout stormwater planters can be implemented in various combinations with the other types of green infrastructure described in these fact sheets. Table 1 in the Introduction provides information on approximate drainage areas that can be treated by various types of green infrastructure BMPs.



## 5. BUMPOUT STORMWATER PLANTER

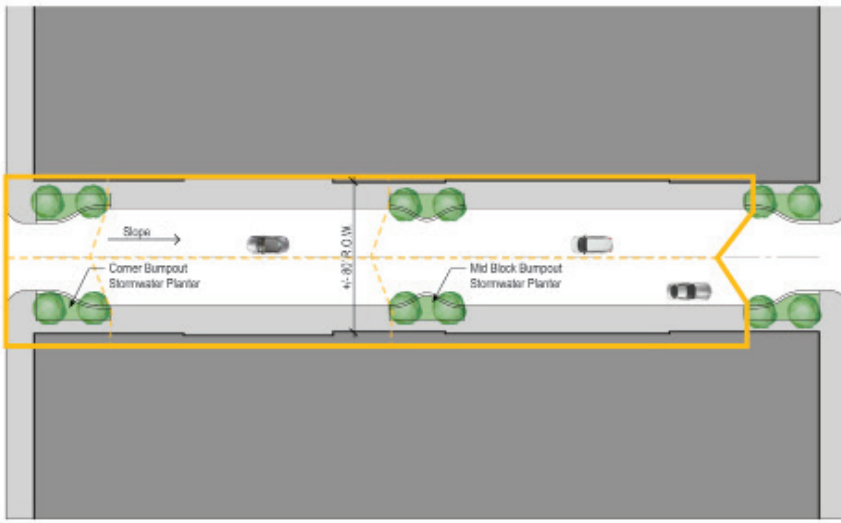

FIGURE 17. Bumpout Stormwater Planter City Block Diagram (Source: Stream Design. 2015.)

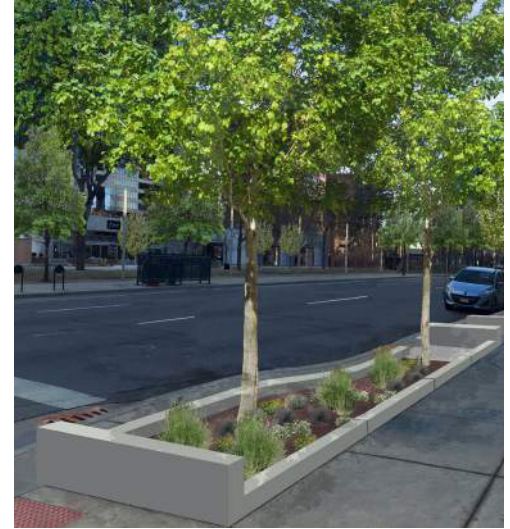

FIGURE 18. Bumpout Stormwater Planter in Urban Landscape (Source: Tetra Tech. 2015.)

### 5.3 PLANTER AESTHETICS AND URBAN DESIGN

Bumpout stormwater planters can be valuable amenities to the urban landscape if designed properly. Designers should take design cues from the surrounding streetscape (if improved) and/or special district urban design element and materials. Planters should match or complement the larger urban context, as well as adding value to the adjacent properties. Since planters are located within the public ROW it is imperative that the design detailing for the planters is uniform within each block, preferably within each district or neighborhood. Figure 18 illustrates how bumpout stormwater planters can be integrated into the urban landscape.

Pedestrian access and safety considerations are discussed in the Section 2.2 Design Criteria. Use of sidewalks and end walls are recommended to discourage the deliberate or inadvertent entry by pedestrians because the top of the planting media in the planters is depressed below the elevation of the sidewalk. While concrete curbs and walls and standard steel railings are part of a typical design palette, designers may explore the use of other materials, such as stone, oversized railings, etc. However, all designs should comply with the City

of Denver Streetscape Design Manual, as well as the Public Works Transportation Standards and Details. In the event of conflicting criteria, these criteria supersede when constructing BMPs included in this manual.

### 5.4 GEOMETRY

The conceptual design details at the back of this fact sheet illustrate the geometry and design features of a bumpout stormwater planter. The details are intended to provide a basis for the designer's final construction documents, although a site-specific design will be necessary for addressing geotechnical issues, structural design, utility protection and relocation, tying in underdrain to a downstream storm drain or outfall, irrigation design, vegetation plan, and associated final design and construction document preparation tasks.

### WIDTH

Since the bumpout provides additional amenity zone between the curb and sidewalk, bumpout planters have a greater width than streetside stormwater planters. This increase width can be as much as 7 feet: approximately 6 feet by occupying the parking lane and one additional foot by reducing the step-out zone for no parking. Assuming a streetside planter typically has



## 5. BUMPOUT STORMWATER PLANTER

an inside width of 5 feet, the bumpout stormwater planter could be up to 12 feet in width. Areas that have a minimum width of 5 feet can incorporate trees.

### LENGTH

Section 2.2 Design Criteria provides a discussion of design considerations associated with planter length. Those considerations translate into a typical range of lengths from about 20 feet to a maximum of 40 feet with adjacent access points on the ends at least four feet wide.

### PROFILE

As mentioned in Section 2.2 Design Criteria, it is recommended that the top of the bioretention media be horizontal in longitudinal profile, and that the top of the side walls be configured to be parallel to the sidewalk at a height of 6 inches or greater, as shown in the details.

If openings in the sidewall along the sidewalk are not used to provide drainage into the planter, the top of the walls can be designed to be horizontal, parallel to the top of the media, for the whole length of the planter. In this case, the water quality water surface can be retained within the planter even with steeper street slopes, as discussed in Section 2.2 Design Criteria.

### 5.5 PLANTER DESIGN CONSIDERATIONS WQCV ZONE

In keeping with USDCM Vol. 3 criteria for bioretention facilities, a WQCV zone is required above the planting media. Although it is possible to design stormwater planters with a water quality depth as great as 12 inches, from an aesthetic standpoint it is desirable to keep the top of the media as high as possible relative to the adjacent sidewalk elevation. For this reason, in bumpout stormwater planters the range will typically be 6 inches to 9 inches, extending from the top of the planting media to the elevation of the flow line at the inlet that controls when water will start to flow out of the planter and down the gutter.

The details at the end of this fact sheet illustrate the critical flow line elevation that defines the water quality water surface.

In addition to the surface volume extending from the top of the media up to the water quality water surface, the volume of the pore spaces in the media equivalent to 14 percent of the media and filter material volume can be counted toward the required WQCV in the ultra-urban green infrastructure BMPs documented in this manual. This pore space volume was selected based on testing of media approximately 24 hours after saturation. As stated in the Section 2.2 Design Criteria, the required WQCV for the upstream area draining to a bumpout stormwater planter shall be computed using the procedures in USDCM Vol. 3. It is important to ensure that the area of the filter (the flat surface of the bioretention media) is sized appropriately for the tributary area. The filter area shall be no less than 2 percent of the upstream area draining to the planter.

### INLET AND SEDIMENT COLLECTION PAD

A concrete sediment collection pad is recommended immediately downstream of the inlet to dissipate energy and collect a portion of the sediment and debris entering the planter for subsequent removal during maintenance operations. Additional information on inlet layout and sizing is provided in Section 2.2 Design Criteria.

### OTHER PLANTER COMPONENTS

Section 2.2 Design Criteria provides information regarding the following components of a bumpout stormwater planter:

- bioretention media
- underdrain system
- flow control structure
- walls
- sidewalk drainage
- spillway
- liner





## 5. BUMPOUT STORMWATER PLANTER

### 5.6 VEGETATION

#### TYPICAL PLANTING PLANS

General information on plant selection, critical success factors for establishment, and maintenance considerations are discussed in Section 2.2 Design Criteria. Typical planting plans specific for a bumpout stormwater planter are described in this section. A recommended plant list is provided in Appendix C and a list of suitable trees is provided in Appendix D.

Custom planting designs should be developed for each project. Designs should take into account site characteristics such as shade, urban or residential character, planter size, and above all, anticipated maintenance schedule and responsibilities. Designs should also reflect neighborhood or district-wide planting approaches and plant palettes. Several typical planting plans are provided below. These are intended to provide examples of different planting approaches, in a range of styles and maintenance levels. The use of non-plant landscape materials such as stone or boulders is not recommended as it will reduce infiltration. Regardless of the type of planting plan, a zone of dense vegetation is recommended adjacent to the concrete sedimentation pad to help dissipate the energy of incoming flows and promote deposition of sediment and debris on the pad.

#### BASIC GRASS COVER

FIGURE 19. Basic Grass Cover Planting Plan (Source: Stream Design. 2015.)  
Scale: 1" = 10'

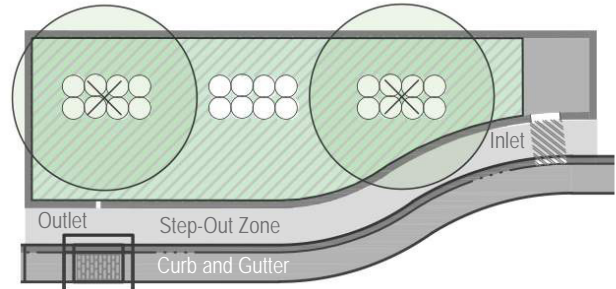

#### PLANT LEGEND



Native grasses at triangular spacing to uniformly cover and fill the planter area with 6"-18" spacing. Preferred species include:

- *Bouteloua gracilis* 'Blonde Ambition'
- *Deschampsia cespitosa* 'Tufted Hairgrass'
- *Schizachyrium scoparium* 'Prairie Blues'
- *Muhlenbergia reverchonii* 'Undaunted Ruby'
- *Sporobolus heterolepis* 'Prairie Dropseed'



30" - 48" tall accent plant (native grass or approved perennial or shrub)

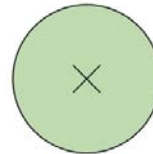

Tree per CCD Forestry recommendation

The Basic Grass Cover plan shown in Figure 19 comprises a relatively simple arrangement of primarily native grasses with some accent plants intended to create essentially full coverage of the bioretention media. The Basic Grass Cover plan is intended to create a "wall-to-wall" planting of low to mid height native and ornamental grasses, with variety provided by clusters of taller grasses, perennials or shrubs in the center of the planter. While regular maintenance is required, the simple design of the Grass Cover plan allows easier identification of weeds by maintenance staff.









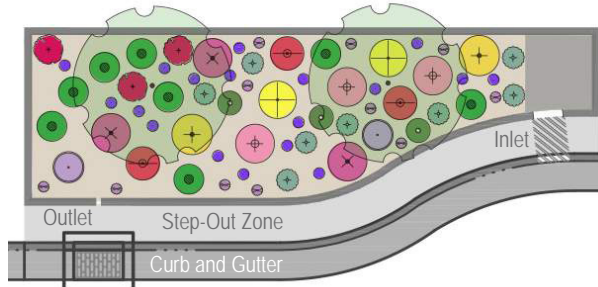





## 5. BUMPOUT STORMWATER PLANTER

### WESTERN PRAIRIE

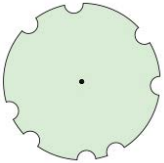
FIGURE 20. Western Prairie Planting Plan (Source: Stream Design. 2015.)  
Scale: 1" = 10'



#### PLANT LEGEND

- |   |   |  |   |
|---|---|--|---|
|    | <i>Andropogon gerardii</i><br>'Windwalker Big Bluestem Grass' |   | <i>Schizachyrium scoparium</i><br>'Prairie Blues'   |
|    | <i>Camassia leichtlinii</i><br>'Blue Danube'                  |   | <i>Sporobolus heterolepis</i><br>'Prairie Dropseed' |
|    | <i>Phlox paniculata</i><br>'David'                            |   | <i>Aster laevis</i><br>'Bluebird'                   |
|    | <i>Liatris ligulistylis</i><br>'Rocky Mountain Gayfeather'    |  | Tree per CCD Forestry recommendation                |
|  | <i>Monarda fistulosa</i><br>'Eastern Bergamot'                |  |   |
|  | <i>Muhlenbergia reverchonii</i><br>'Undaunted Ruby'           |  |   |
|  | <i>Monarda bradburiana</i><br>'Wild Bergamot'                 |  |   |
|  | <i>Ratibida pinnata</i><br>'Pinnate Prairie Coneflower'       |  |   |
|  | <i>Anaphalis margaritacea</i><br>'Western Pearly Everlasting' |  |   |







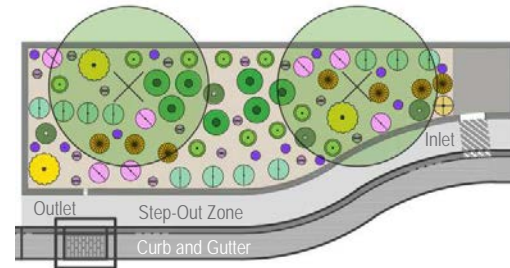



The Western Prairie typical planting plan illustrated in Figure 20 is intended to present an image of a “natural” prairie. Primarily native grasses and herbaceous perennials, this plan is arranged in a naturalistic style that allows for the planting to change with time as certain species thrive and others recede. While all bumpout stormwater planters will require a significant amount of maintenance to keep them weed free and healthy, this planting plan can be more forgiving and will require less maintenance than more formal approaches.

### MODERN MATRIX

FIGURE 21. Modern Matrix Planting Plan (Source: Stream Design. 2015.)  
Scale: 1" = 10'



#### PLANT LEGEND

- |   |   |  |   |
|---|---|--|---|
|    | <i>Amorpha canescens</i><br>'Leadplant'                       |   | <i>Sporobolus heterolepis</i><br>'Prairie Dropseed' |
|    | <i>Anaphalis margaritacea</i><br>'Western Pearly Everlasting' |  |   |
|    | <i>Calamagrostis × acutiflora</i><br>'Karl Foerster'          |  |   |
|    | <i>Camassia leichtlinii</i><br>'Blue Danube'                  |  | Tree per CCD Forestry recommendation                |
|  | <i>Liatris ligulistylis</i><br>'Rocky Mountain Gayfeather'    |  |   |
|  | <i>Panicum virgatum</i><br>'Northwind'                        |  |   |
|  | <i>Panicum virgatum</i><br>'Prairie Sky'                      |  |   |
|  | <i>Monarda bradburiana</i><br>'Wild Bergamot'                 |  |   |
|  | <i>Helianthus maximiliana</i><br>'Dakota Sunshine'            |  |   |

The Modern Matrix plan uses drought tolerant native materials and groups them in regular clusters and groupings to create a more organic, urban garden. A typical plan is shown in Figure 21. While individual plant species are chosen for drought tolerance and hardiness, the more ordered approach may require slightly more maintenance to maintain its character and look attractive versus the other approaches illustrated.



## 5. BUMPOUT STORMWATER PLANTER

### 5.7 BUMPOUT STORMWATER PLANTER DETAILS

A typical design of a bumpout stormwater planter is illustrated in a series of detail drawings in this section. The details indicate various elements of the planter and representative dimensions. The designer is responsible for preparing final construction drawings suitable for the specific conditions, water quality requirements, utilities, and constraints existing in the location where the BMP is to be sited. A geotechnical engineer should consult on soil conditions and recommendations for lining. A structural engineer, with input from the geotechnical engineer shall design concrete elements, including wall thickness, reinforcing (reinforcing shown in details is representative only), any foundation components such as footings or bottom slab, and subgrade/bedding/backfill specifications. A site-specific design will also be necessary for addressing utility protection and relocation, tying in underdrain to a downstream storm drain or outfall, irrigation design, vegetation plan, and associated final design and construction document preparation tasks.

The following design notes apply to the detail drawings.

### DESIGN NOTES

1. INLET WIDTH VARIES BASED ON UPSTREAM IMPERVIOUS AREA AND STREET SLOPE, WITH A MINIMUM WIDTH OF 2 FEET AND A MAXIMUM WIDTH OF 3 FEET. SEE CRITERIA FOR SIZING INLET WIDTH IN INTRODUCTION SECTION.
2. INLET COVER SHALL SUPPORT ADA ACCESSIBILITY REQUIREMENTS AND CONSIST OF NEENAH R-4999 HEAVY DUTY BOLTED TRENCH GRATE TYPE D (SOLID) OR APPROVED EQUIVALENT – CATALOGUE NO. R-4999-HX FOR SPAN OF 2 FEET AND R-4999-MX FOR SPAN OF 3 FEET. THE LENGTH OF THE INLET COVER SHOULD BE FIELD CUT TO EXTEND CONTINUOUSLY FROM THE FACE OF CURB TO BACK OF PLANTER WALL AND SHOULD BE RECESSED FROM THE FACE OF THE CURB SO THAT THE CORNERS OF THE PLATE DO NOT PROTRUDE BEYOND THE TOP OF CURB.
3. STRUCTURAL ENGINEER, WITH INPUT FROM GEOTECHNICAL ENGINEER, SHALL DESIGN WALL DIMENSIONS, REINFORCING, ANY FOUNDATION COMPONENTS SUCH AS FOOTINGS OR BOTTOM SLAB, AND SUBGRADE/BEDDING/BACKFILL SPECIFICATIONS.
4. IN AREAS WHERE PARKING IS ALLOWED, THE MINIMUM STEP-OUT ZONE WIDTH FROM BACK OF CURB TO OUTER WALL OF PLANTER IS 2 FEET 6 INCHES. IN AREAS WHERE PARKING IS NOT ALLOWED, THE MINIMUM RECOMMENDED SPLASH STRIP WIDTH FROM BACK OF CURB TO OUTER WALL OF PLANTER IS 1 FOOT 6 INCHES.
5. FOR STREET SLOPES LESS THAN 5.5 PERCENT, THE ELEVATION OF THE FLOW LINE AT POINT A REPRESENTS THE WATER SURFACE ELEVATION ABOVE WHICH WATER IN THE PLANTER WOULD START TO FLOW OUT AND BE CONVEYED DOWN THE GUTTER. THIS ELEVATION IS EQUAL TO THE WATER QUALITY WATER SURFACE AND IS THE TOP OF THE WATER QUALITY CAPTURE VOLUME (WQCV).
6. FOR STREET SLOPES GREATER THAN 5.5 PERCENT, THE ELEVATION OF THE FLOW LINE AT POINT B REPRESENTS THE WATER SURFACE ELEVATION ABOVE WHICH WATER IN THE PLANTER WOULD START TO FLOW OUT AND BE CONVEYED DOWN THE GUTTER.



## 5. BUMPOUT STORMWATER PLANTER

- THIS ELEVATION IS EQUAL TO THE WATER QUALITY WATER SURFACE AND IS THE TOP OF THE WATER QUALITY CAPTURE VOLUME.
7. THE WATER CONTROL STRUCTURE IS COMPRISED OF AN INCLINE WATER LEVEL CONTROL STRUCTURE AS SHOWN IN THE DETAILS. THIS STRUCTURE HOUSES A CONTROL ORIFICE DESIGNED TO RELEASE THE WQCV IN 12 HOURS AND A WEIR SET WITHIN 2 INCHES BELOW TO 2 INCHES ABOVE THE WATER QUALITY WATER SURFACE. THE WATER CONTROL STRUCTURE SHALL BE AN AGRI DRAIN INLINE WATER LEVEL CONTROL STRUCTURE AS MANUFACTURED BY AGRI DRAIN CORPORATION, OR APPROVED EQUIVALENT.
  8. THE UNDERDRAIN SHALL MEET THE MATERIAL AND SLOT SPECIFICATIONS IDENTIFIED IN USDCM VOLUME 3. THE MINIMUM LENGTH OF SLOTTED UNDERDRAIN SHALL BE 4 FEET.
  9. THE WATER QUALITY WATER SURFACE IS THE TOP OF THE WQCV AND IS EQUAL TO THE ELEVATION OF THE FLOW LINE AT POINT A FOR STREET SLOPES LESS THAN 5.5 PERCENT AND AT POINT B FOR STREET SLOPES GREATER THAN 5.5 PERCENT.
  10. BIORETENTION MEDIA SHALL MEET THE SPECIFICATIONS IDENTIFIED IN THE DESIGN CRITERIA SECTION OF THE INTRODUCTION. TOP OF MEDIA SHALL BE PER PLAN AND A MINIMUM OF 6 INCHES AND A MAXIMUM OF 9 INCHES BELOW THE WQCV WATER SURFACE ELEVATION.
  11. FILTER MATERIAL SHALL MEET THE SPECIFICATIONS IDENTIFIED IN USDCM VOLUME 3. FILTER MATERIAL (NOT BIORETENTION MEDIA) SHALL BE COMPACTED TO A DENSITY OF NOT LESS THAN 70 PERCENT OF RELATIVE DENSITY DETERMINED IN ACCORDANCE WITH ASTM D4253 AND D4254 (FOR FINES CONTENT LESS THAN 5 PERCENT).
  12. THE UNDERDRAIN CLEANOUT SHALL CONSIST OF 4 INCH POLYVINYL CHLORIDE (PVC) PIPE WITH TWO 45 DEGREE BENDS AND A THREADED CAP SET 2 INCHES ABOVE THE TOP OF THE BIORETENTION MEDIA.
  13. PROVIDE A GAP IN THE SIDEWALL OR DEPRESSED SECTION (SPILLWAY) AT THE DOWNSTREAM END OF THE STREETSIDE PLANTER WALL AT LEAST 2 FEET LONG TO ENSURE THAT OVERFLOWS FROM PLANTER WILL EXIT ON THE STREETSIDE. THE CREST OF THE SPILLWAY SHALL BE SET AT THE WQCV WATER SURFACE ELEVATION.
  14. STRUCTURAL BACKFILL SHALL CONSIST OF CDOT CLASS 1 OR 2 STRUCTURE BACKFILL, AS DETERMINED BY ENGINEER AND COMPACTED TO AT LEAST 95 PERCENT OF MAXIMUM DENSITY IN ACCORDANCE WITH ASTM D698.









5. BUMPOUT STORMWATER PLANTER

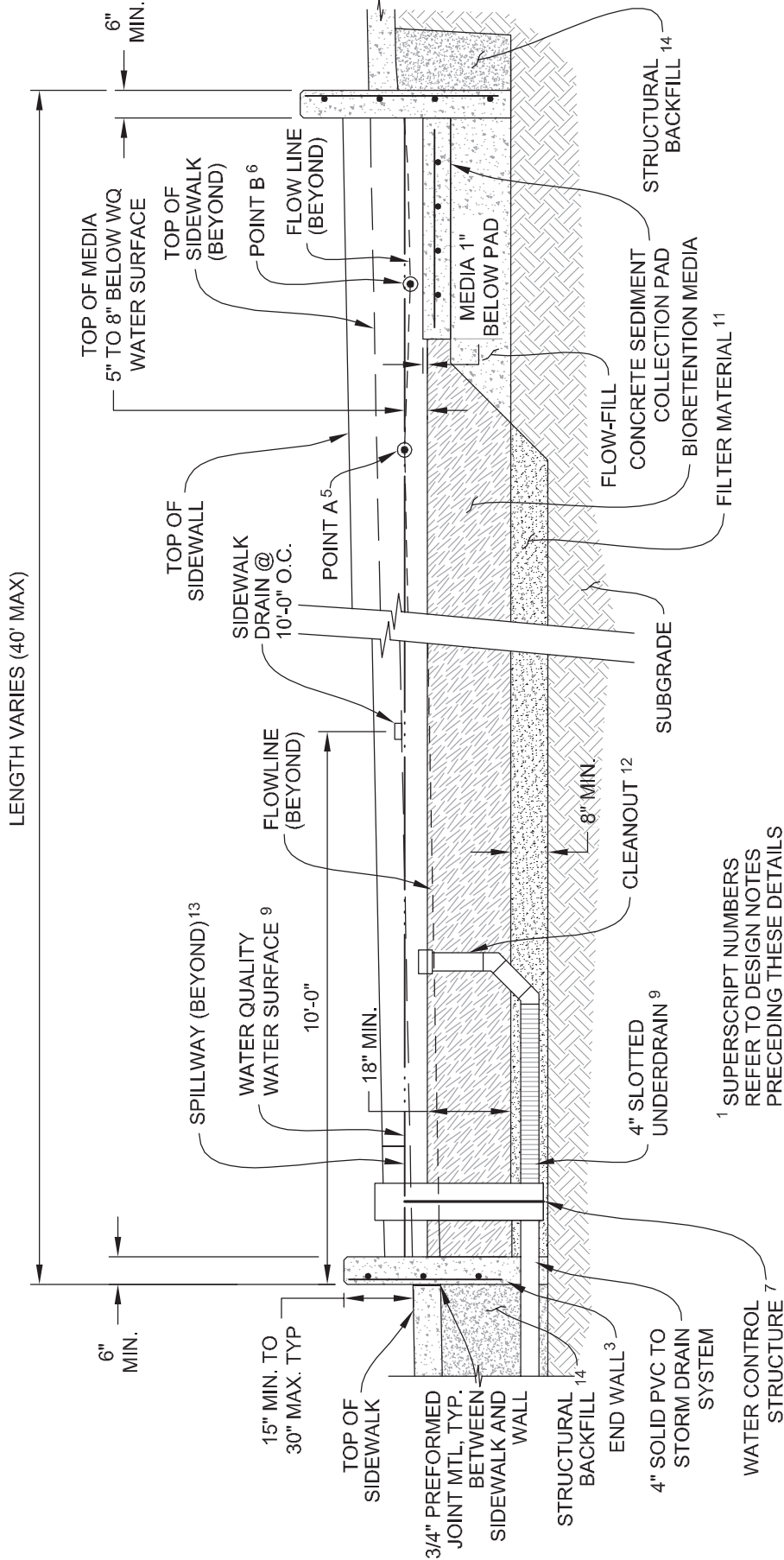

STREETSIDE BUMPOUT STORMWATER PLANTER - SECTION 2

(LONGITUDINAL SLOPE OF 2% SHOWN WITH 40' PLANTER LENGTH)  
SCALE: 1"=3'





5. BUMPOUT STORMWATER PLANTER

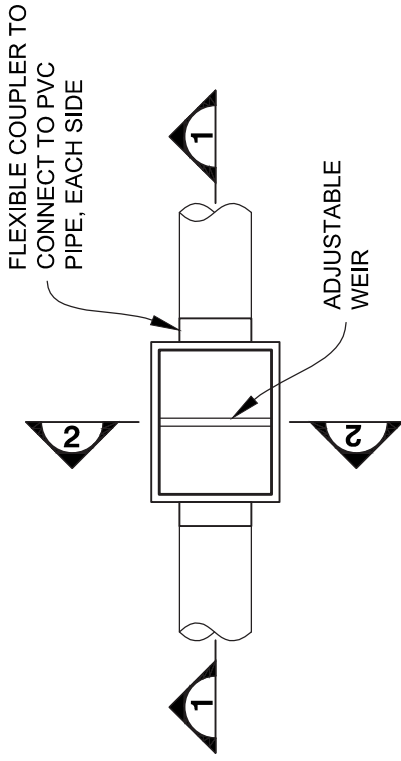

WATER CONTROL STRUCTURE - PLAN  
SCALE: 1"=1'

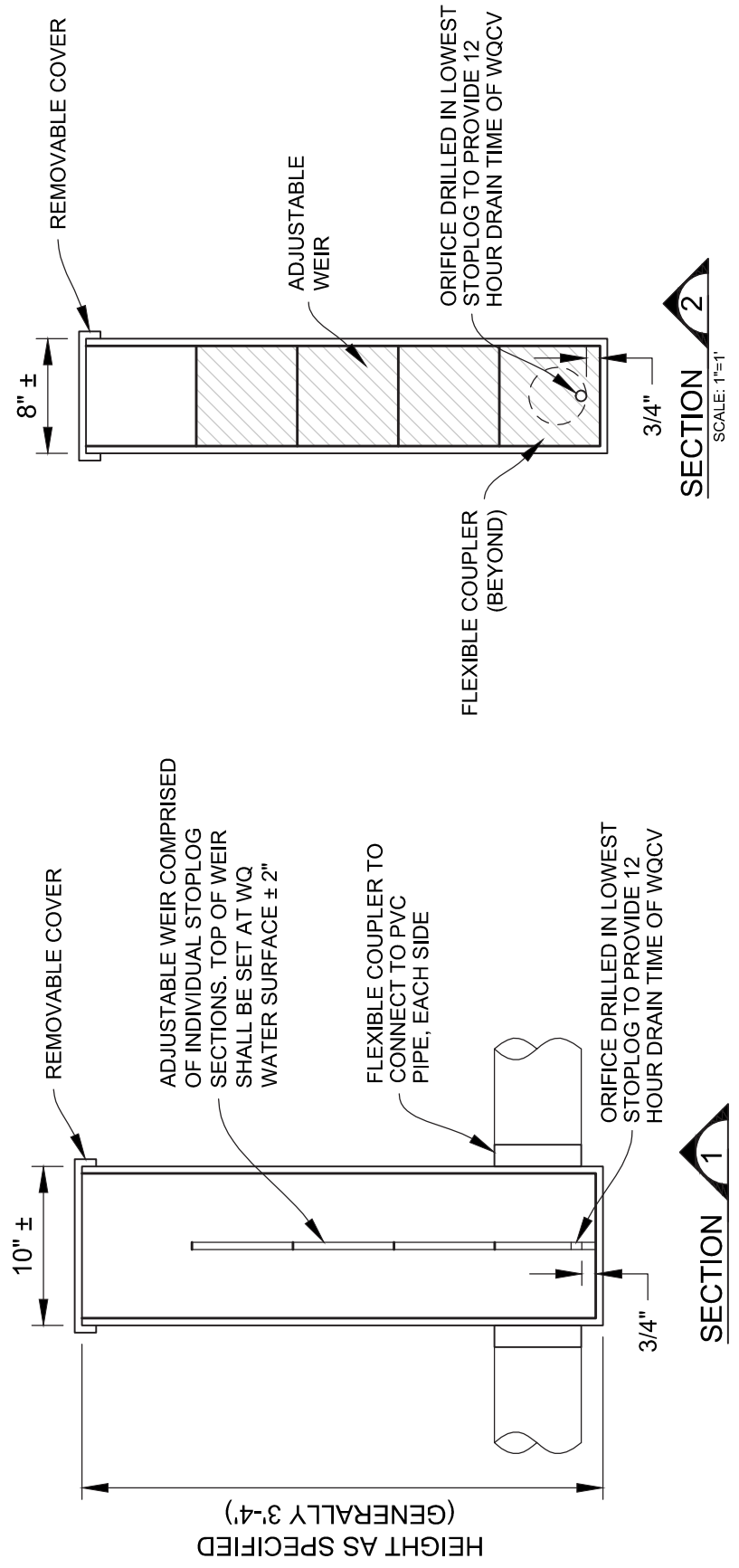

# 6. GREEN GUTTER

## 6.1 DESCRIPTION

A green gutter is a type of bioretention facility located within a street section near the gutter line. This fact sheet illustrates the use of a green gutter between the vehicular lanes of a roadway and a bike lane. A green gutter is intended to provide water quality treatment of runoff from the street and adjacent bike lane and pedestrian zone if the bike lane slopes toward the green gutter. If the bike lane drains toward the sidewalk (as might be the case in a retrofit condition), the green gutter drains the vehicular lanes. Stormwater runoff enters the green gutter through a curb opening and chase-type inlet, spreads over the planting media, infiltrates vertically downward, and exits through an underdrain. Treatment processes include filtration, soil adsorption, and plant uptake.

Green gutters should be well vegetated to maximize functionality and attractiveness. While a variety of vegetation can potentially

thrive in these green gutters, a neat clean appearance is recommended by using a simple palette that primarily includes native grasses. Except as noted, a green gutter follows the design guidance provided in the Bioretention Fact Sheet in Urban Drainage and Flood Control District's (UDFCD) Urban Storm Drainage Criteria Manual, Volume 3 (USDCM Vol. 3). This fact sheet provides specific design guidance for the application of bioretention to a green gutter. Detailed drawings and notes are provided at the back of this fact sheet to further illustrate the design of green gutters.

Figure 23 illustrates how a green gutter can be integrated into a typical street section. The figure shows the basic elements of the green gutter in cross section and in perspective. Figure 24 represents an isometric diagram of a green gutter stormwater planter.

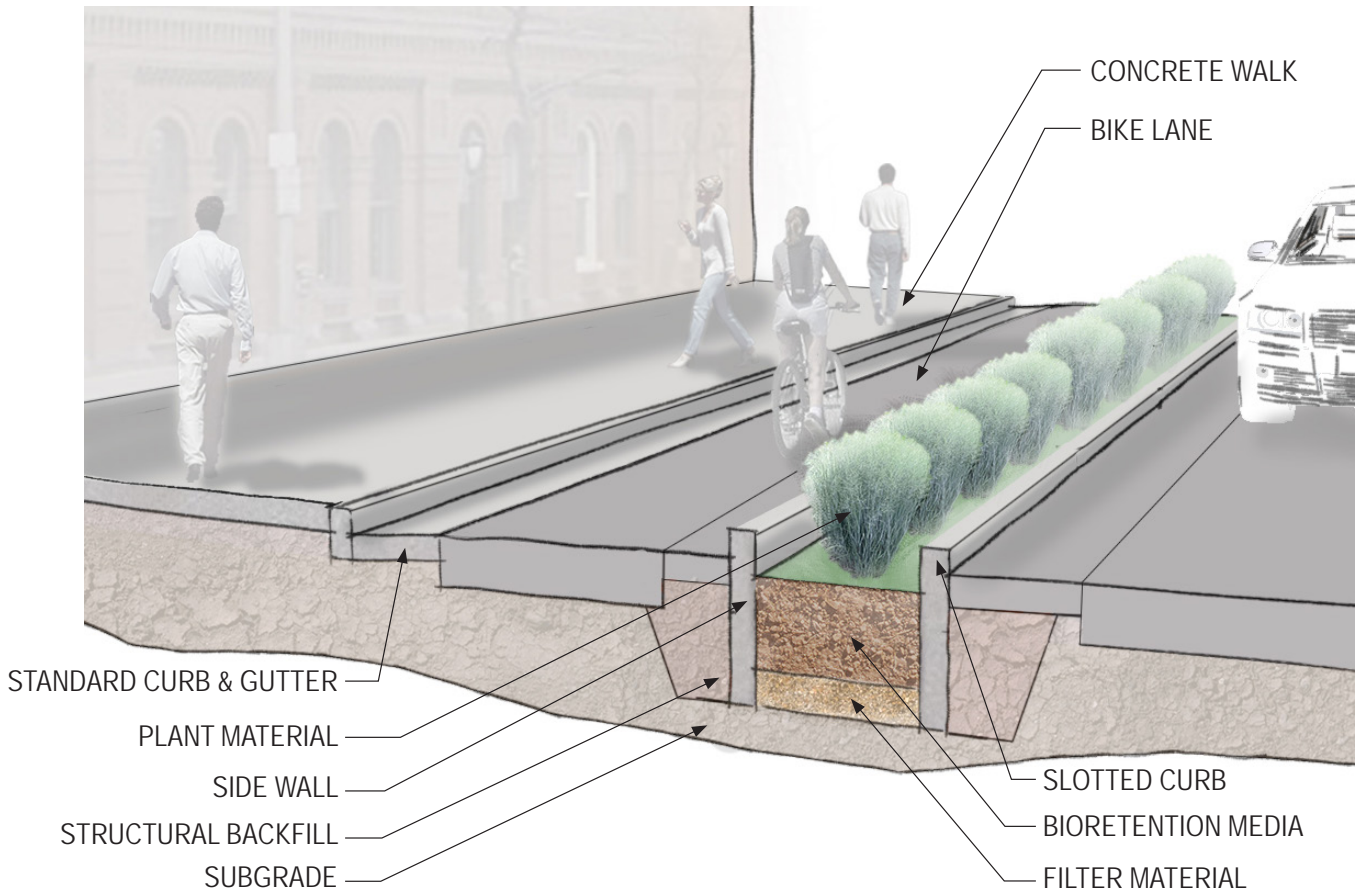

FIGURE 23. Green Gutter  
(Source: Stream Design, 2015.)



## 6. GREEN GUTTER

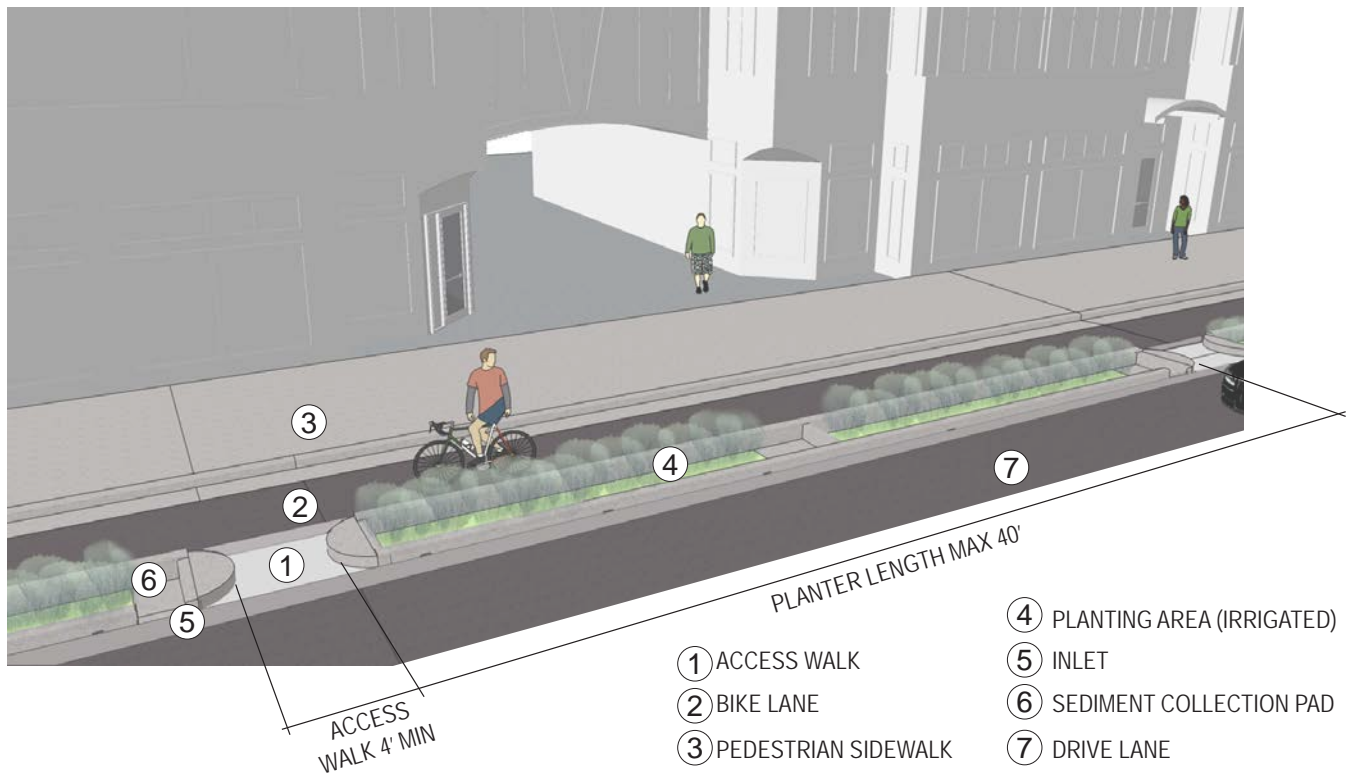

FIGURE 24. Green Gutter (Source: Stream Design, 2015.)

### 6.2 USES AND RECOMMENDATIONS

Green gutters are intended to run down the length of a block with gaps as necessary to provide pedestrian access across the green gutter. They are appropriate to capture stormwater on roadways that do not receive a deleterious amount of deicing salts. If serving just the public right-of-way (ROW; street, bike lane, and pedestrian zone), a continuous section of a 3 foot wide green gutter can satisfy the crown to ROW line water quality requirements for Denver's local, collector, or arterial roadway classifications for total ROW widths up to 110 feet.

Other types of green infrastructure described in these fact sheets can be implemented in combination with green gutter stormwater planters. Table 1 in the Introduction provides information on approximate drainage areas that can be treated by various types of green infrastructure BMPs.

### 6.3 GREEN GUTTER AESTHETICS AND URBAN DESIGN

In an urban design context, green gutters are primarily used to separate uses for aesthetic or safety purposes, such as the example of the bike lane adjacent to a major roadway. As such, the design of green gutters should emphasize safety above all. Aesthetic considerations for these green gutters should focus on assuring their integration into the design of the overall streetscape and/or district urban design character, including the use of similar or complementary materials, colors, and design.

In addition, green gutters should be planned and designed to accommodate necessary pedestrian cross traffic, and their length should be determined to assure smooth pedestrian flow through a district or neighborhood. As green gutters are intended to be installed within street ROWs, all requirements for vehicular



## 6. GREEN GUTTER

safety per the City of Denver Public Works standards must be maintained, including the maintaining of proper sight distance at intersections. In addition, green gutter design must comply with the Denver Public Works Transportation Standards and Details.

### 6.4 GEOMETRY

The conceptual design details at the back of this fact sheet illustrate the geometry and design features of a green gutter. The details are intended to provide a basis for the designer's final construction documents, although a site specific design will be necessary addressing geotechnical issues, structural design, utility protection and relocation, tying in underdrain to a downstream storm drain or outfall, irrigation design, vegetation plan, and associated final design and construction document preparation tasks.

### WIDTH

Green gutters should be made as wide as possible within the

available roadway section based on desired widths of the vehicular lanes and bike lane. A recommended minimum width is 3 feet from inside of curb to inside of curb.

### LENGTH AND GUTTER PROFILE

The length of a green gutter is established based on the need to provide periodic pedestrian access and also based on the length and width necessary to obtain a specific water quality capture volume (WQCV) associated with the upstream drainage area to be treated. Since the top of the bioretention media will be horizontal in longitudinal profile while the street and top of curbs will slope, periodic drops may be necessary as shown in the details to "stairstep" the media and water quality water surface down in a downstream direction.

Figure 25 provides guidance on maximum length of each green gutter section based upon the longitudinal slope of the roadway and the vertical drop across the bioretention media.

FIGURE 25. Maximum length of green gutter section based on roadway longitudinal slope and vertical drop across bioretention media.

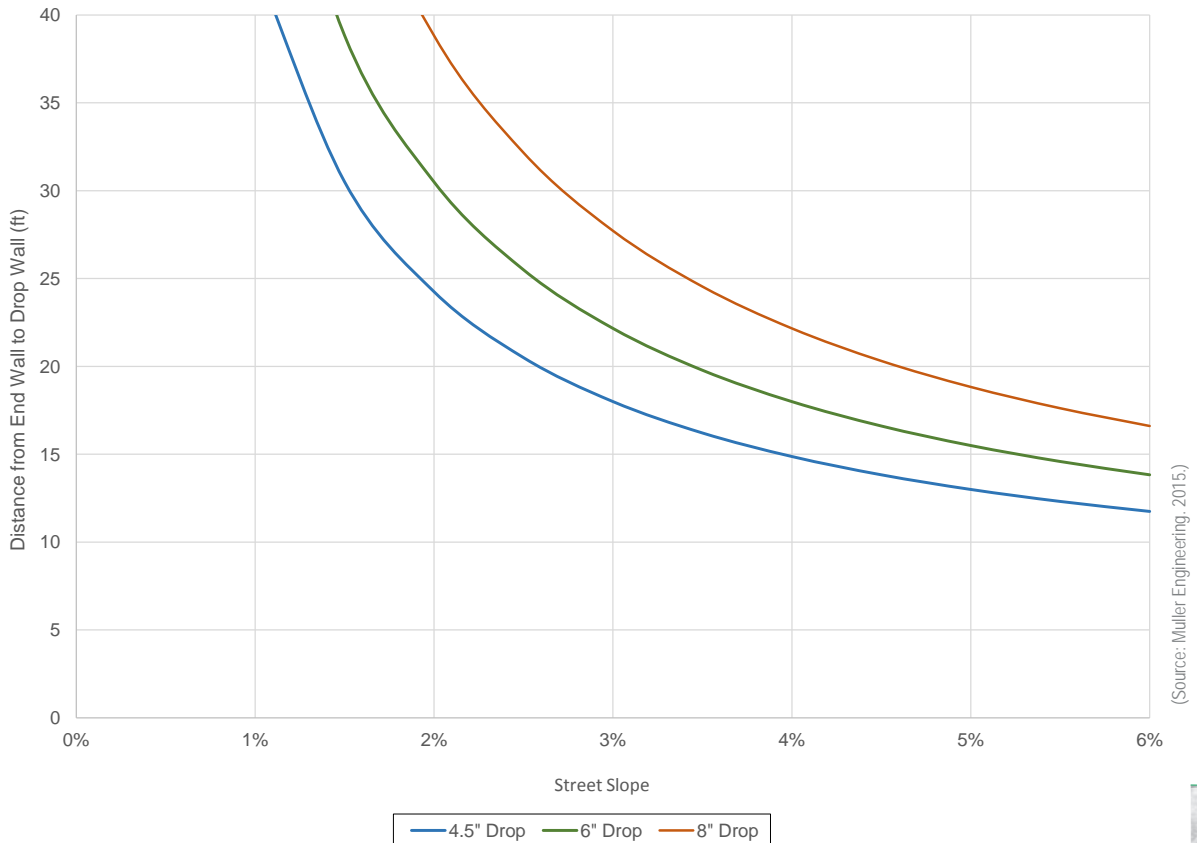

## 6. GREEN GUTTER

### 6.5 GREEN GUTTER DESIGN CONSIDERATIONS

#### WQCV ZONE

In keeping with USDCM Vol. 3 criteria for bioretention facilities, a WQCV zone is required above the planting media. This zone is measured from the top of the media to the elevation of the flow line at the inlet that controls when water will start to flow out of the planter and down the gutter. Although it is possible to design green gutters with a water quality depth as great as 12 inches, from an aesthetic standpoint it is desirable to keep the top of the media as high as possible relative to the adjacent pavement elevation. For this reason, the top of the media will typically be set 5 inches to 9 inches below the water quality water surface. The details at the end of the fact sheet illustrate the critical flow line elevation that defines the water quality water surface.

In addition to the surface volume extending from the top of the media up to the water quality water surface, a portion of the volume of the pore spaces in the media equivalent to 14 percent of the media and filter material volume can be counted toward the required WQCV in the ultra-urban green infrastructure BMPs documented in this manual. This pore space volume was selected based on testing of media approximately 24 hours after saturation. As stated in Section 2.2 Design Criteria of the Introduction, the required WQCV for the upstream area draining to a green gutter stormwater planter shall be computed using the procedures UDSCM Vol. 3. It is also important to ensure that the area of the filter (the flat surface area of the bioretention media) is sized appropriately for the tributary area. The filter area shall be no less than the 2 percent of the upstream area draining to the green gutter.

#### INLET AND SEDIMENTATION COLLECTION PAD

A concrete sediment collection pad is recommended immediately downstream of the inlet to dissipate energy and collect a portion of the sediment and debris entering the planter for subsequent removal during maintenance operations.

Additional information on inlet layout and sizing is provided in Section 2.2 Design Criteria.

### OTHER PLANTER COMPONENTS

Section 2.2 Design Criteria provides information regarding the following components of a green gutter stormwater planter:

- bioretention media
- underdrain system
- flow control structure
- walls
- spillway
- liner

### 6.6 VEGETATION BASIC GRASS COVER PLANTING

Given the limited width of the green gutter and the relatively challenging growing conditions created by the surrounding hardscape, the planting plan recommended for most green gutter applications is the “Basic Grass Cover” concept. This concept consists of a simple arrangement of primarily native grasses to create full coverage of the bioretention media. This planting scheme is intended to create a “wall to wall” planting of low to mid height native grasses. Variety can be created within the planter by alternating masses of grass species, or inserting clusters of accent grasses that contrast from the main species in size, color, or texture (all plant heights should be below 30 inches). While regular maintenance is required, the simple design of the Basic Grass Cover allows easier identification of weeds by maintenance staff. Designers should take into account mature sizes of plant material when developing planting layout plans to assure that the established plant material is not planted so close to planter edges that plants significantly exceed the limits of the planting area and create hazards for adjoining use areas. Information on sizes and spacing of recommended species is provided in Appendix C.



## 6. GREEN GUTTER

### 6.7 GREEN GUTTER DETAILS

A typical design of a green gutter is illustrated in a series of detail drawings in this section. The details indicate various elements of the planter and representative dimensions. The designer is responsible for preparing final construction drawings suitable for the specific conditions, water quality requirements, utilities and constraints existing in the location where the BMP is to be sited. A geotechnical engineer shall consult on soil conditions and recommendations for lining. A structural engineer, with input from the geotechnical engineer shall design concrete elements, including wall thickness, reinforcing (reinforcing shown in details is representative only), any foundation components such as footings or bottom slab, and subgrade/bedding/ backfill specifications. A site-specific design will also be necessary addressing utility protection and relocation, tying in underdrain to a downstream storm drain or outfall, irrigation design, vegetation plan, and associated final design and construction document preparation tasks.

The following design notes apply to the detail drawings.

### DESIGN NOTES

1. INLET WIDTH VARIES BASED ON UPSTREAM IMPERVIOUS AREA AND STREET SLOPE, WITH A MINIMUM WIDTH OF 2 FEET AND A MAXIMUM WIDTH OF 3 FEET. SEE CRITERIA FOR SIZING INLET WIDTH IN INTRODUCTION SECTION.
2. INLET COVER SHALL MEET ADA ACCESSIBILITY REQUIREMENTS AND CONSIST OF NEENAH R-4999 HEAVY DUTY BOLTED TRENCH GRATE TYPE D (SOLID) OR APPROVED EQUIVALENT – CATALOGUE NO. R-4999-HX FOR SPAN OF 2 FEET AND R-4999-MX FOR SPAN OF 3 FEET. THE LENGTH OF THE INLET COVER SHOULD BE FIELD CUT TO EXTEND CONTINUOUSLY FROM THE FACE OF CURB TO BACK OF PLANTER WALL AND SHOULD BE RECESSED FROM THE FACE OF THE CURB SO THAT THE CORNERS OF THE PLATE DO NOT PROTRUDE BEYOND THE TOP OF CURB.
3. STRUCTURAL ENGINEER, WITH INPUT FROM GEOTECHNICAL ENGINEER, SHALL DESIGN WALL DIMENSIONS, REINFORCING, ANY FOUNDATION COMPONENTS SUCH AS FOOTINGS OR BOTTOM SLAB, AND SUBGRADE/BEDDING/BACKFILL SPECIFICATIONS.
4. IN AREAS WHERE PARKING IS ALLOWED, THE MINIMUM STEP-OUT ZONE WIDTH FROM BACK OF CURB TO OUTER WALL OF PLANTER IS 2 FEET 6 INCHES. IN AREAS WHERE PARKING IS NOT ALLOWED, THE MINIMUM RECOMMENDED SPLASH STRIP WIDTH FROM BACK OF CURB TO OUTER WALL OF PLANTER IS 1 FOOT 6 INCHES.
5. FOR STREET SLOPES LESS THAN 5.5 PERCENT, THE ELEVATION OF THE FLOW LINE AT POINT A REPRESENTS THE WATER SURFACE ELEVATION ABOVE WHICH WATER IN THE PLANTER WOULD START TO FLOW OUT AND BE CONVEYED DOWN THE GUTTER. THIS ELEVATION IS EQUAL TO THE WATER QUALITY WATER SURFACE AND IS THE TOP OF THE WATER QUALITY CAPTURE VOLUME (WQCV).
6. FOR STREET SLOPES GREATER THAN 5.5 PERCENT, THE ELEVATION OF THE FLOW LINE AT POINT B REPRESENTS THE WATER SURFACE ELEVATION ABOVE WHICH WATER IN THE PLANTER WOULD START TO FLOW OUT AND BE



## 6. GREEN GUTTER

- CONVEYED DOWN THE GUTTER. THIS ELEVATION IS EQUAL TO THE WATER QUALITY WATER SURFACE AND IS THE TOP OF THE WATER QUALITY CAPTURE VOLUME.
7. THE WATER CONTROL STRUCTURE IS COMPRISED OF AN INCLINE WATER LEVEL CONTROL STRUCTURE AS SHOWN IN THE DETAILS. THIS STRUCTURE HOUSES A CONTROL ORIFICE DESIGNED TO RELEASE THE WQCV IN 12 HOURS AND A WEIR SET WITHIN 2 INCHES BELOW TO 2 INCHES ABOVE THE WATER QUALITY WATER SURFACE. THE WATER CONTROL STRUCTURE SHALL BE AN AGRI DRAIN INLINE WATER LEVEL CONTROL STRUCTURE AS MANUFACTURED BY AGRI DRAIN CORPORATION, OR APPROVED EQUIVALENT.
  8. THE UNDERDRAIN SHALL MEET THE MATERIAL AND SLOT SPECIFICATIONS IDENTIFIED IN USDCM VOLUME 3. THE MINIMUM LENGTH OF SLOTTED UNDERDRAIN SHALL BE 4 FEET.
  9. THE WATER QUALITY WATER SURFACE IS THE TOP OF THE WQCV AND IS EQUAL TO THE ELEVATION OF THE FLOW LINE AT POINT A FOR STREET SLOPES LESS THAN 5.5 PERCENT AND AT POINT B FOR STREET SLOPES GREATER THAN 5.5 PERCENT.
  10. BIORETENTION MEDIA SHALL MEET THE SPECIFICATIONS IDENTIFIED IN THE DESIGN CRITERIA SECTION OF THE INTRODUCTION. TOP OF MEDIA SHALL BE PER PLAN AND A MINIMUM OF 6 INCHES AND A MAXIMUM OF 9 INCHES BELOW THE WQCV WATER SURFACE ELEVATION.
  11. FILTER MATERIAL SHALL MEET THE SPECIFICATIONS IDENTIFIED IN USDCM VOLUME 3. FILTER MATERIAL (NOT BIORETENTION MEDIA) SHALL BE COMPACTED TO A DENSITY OF NOT LESS THAN 70 PERCENT OF RELATIVE DENSITY DETERMINED IN ACCORDANCE WITH ASTM D4253 AND D4254 (FOR FINES CONTENT LESS THAN 5 PERCENT).
  12. THE UNDERDRAIN CLEANOUT SHALL CONSIST OF 4 INCH POLYVINYL CHLORIDE (PVC) PIPE WITH TWO 45 DEGREE BENDS AND A THREADED CAP SET 2 INCHES ABOVE THE TOP OF THE BIORETENTION MEDIA.
  13. PROVIDE A GAP IN THE SIDEWALL OR DEPRESSED SECTION (SPILLWAY) AT THE DOWNSTREAM END OF THE STREETSIDE PLANTER WALL AT LEAST 2 FEET LONG TO ENSURE THAT OVERFLOWS FROM PLANTER WILL EXIT ON THE STREETSIDE. THE CREST OF THE SPILLWAY SHALL BE SET AT THE WQCV WATER SURFACE ELEVATION.
  14. STRUCTURAL BACKFILL SHALL CONSIST OF CDOT CLASS 1 OR 2 STRUCTURE BACKFILL, AS DETERMINED BY ENGINEER AND COMPACTED TO AT LEAST 95 PERCENT OF MAXIMUM DENSITY IN ACCORDANCE WITH ASTM D698.





## 6. GREEN GUTTER

FIGURE 26. Green Gutter Details  
(Source: Muller Engineering, 2015.)

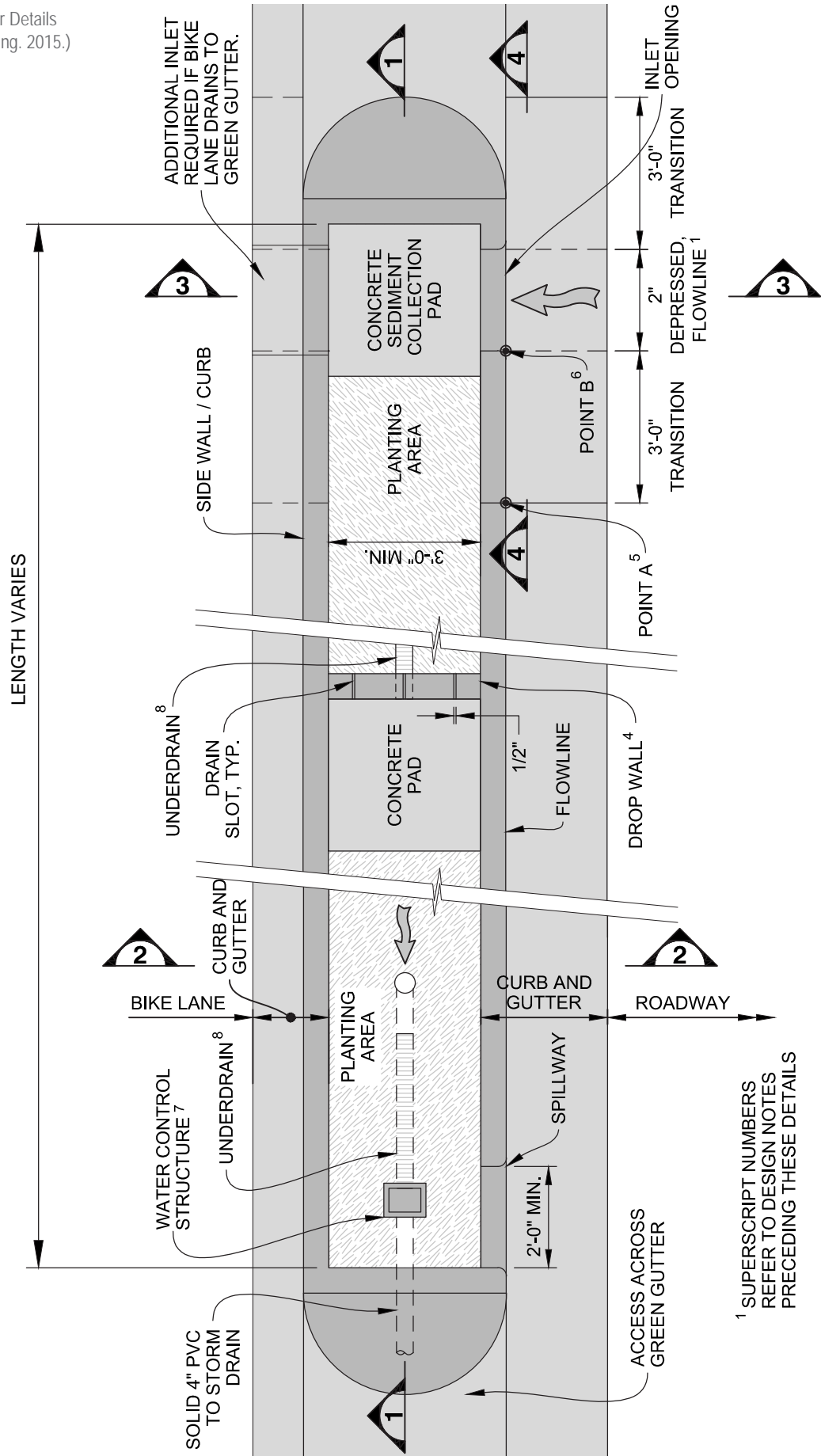

<sup>1</sup> SUPERScript NUMBERS REFER TO DESIGN NOTES PRECEDING THESE DETAILS

### GREEN GUTTER STORMWATER PLANTER PLAN

SCALE: 1"=3'

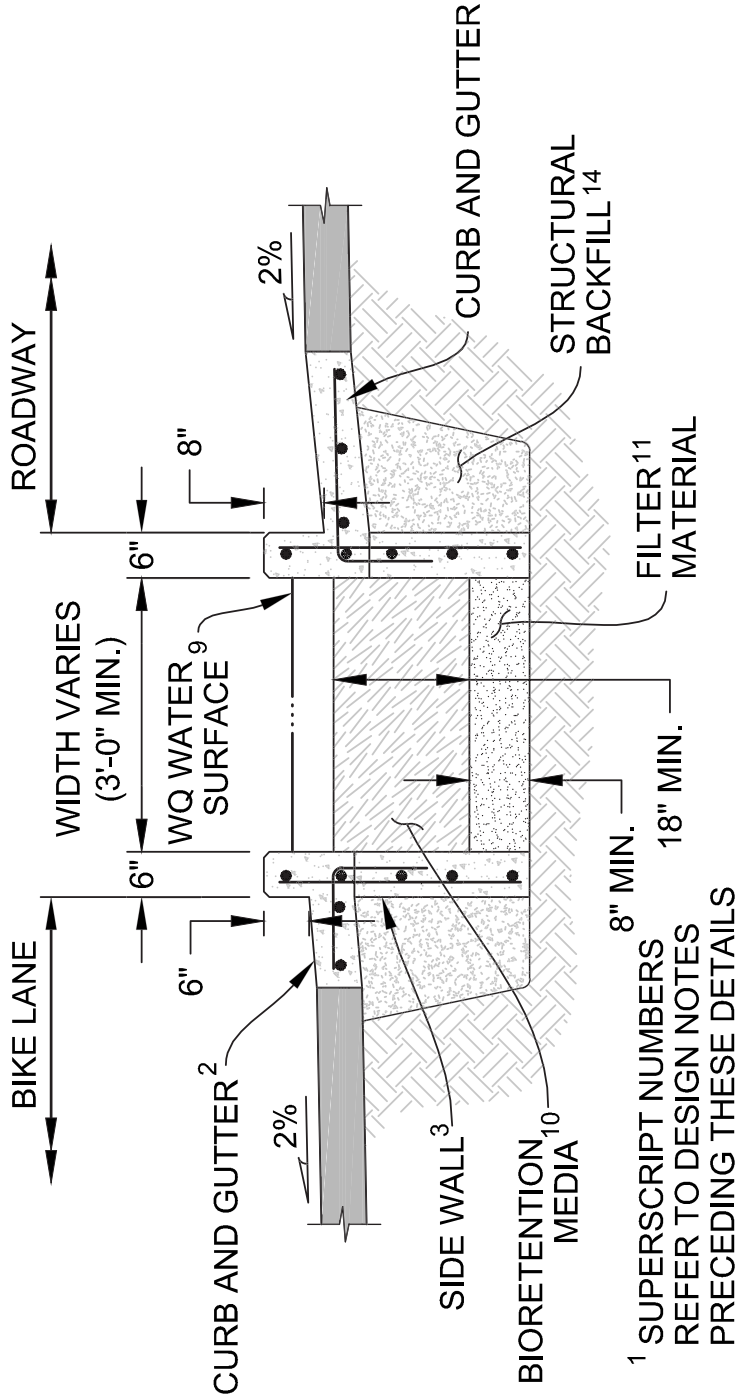

GREEN GUTTER STORMWATER PLANTER - SECTION **2**

SCALE: 1"=3'





6. GREEN GUTTER

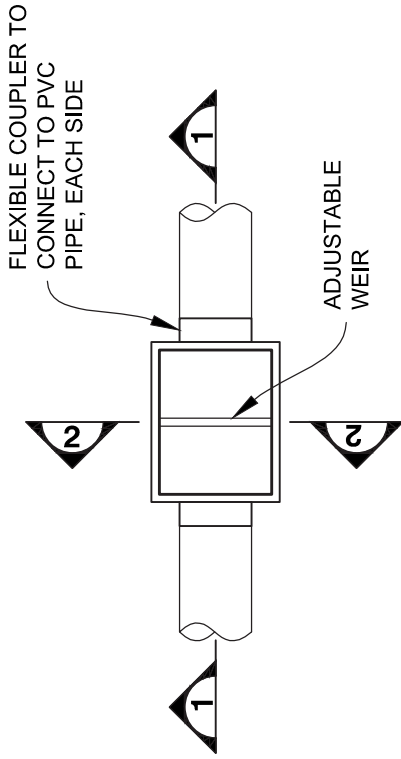

WATER CONTROL STRUCTURE - PLAN  
SCALE: 1"=1'

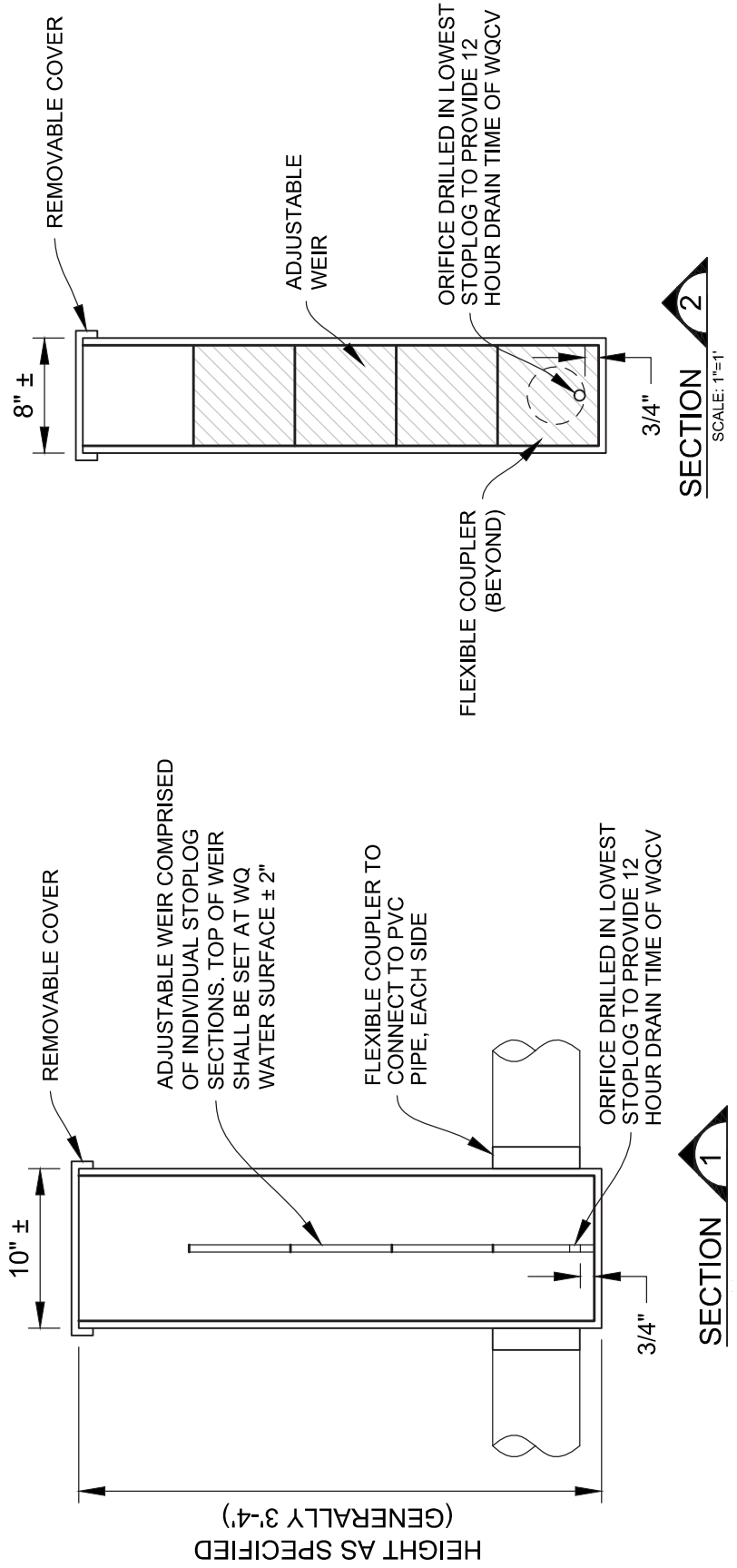

# 7. GREEN ALLEY

## 7.1 DESCRIPTION

A green alley is a type of stormwater quality facility applied to alleys. A green alley is intended to provide water quality treatment of runoff from the alley through the use of permeable pavement, although may be modified to provide some level of water quality treatment for adjoining development. This fact sheet illustrates the configuration of a green alley serving the water quality needs of the alley itself. The alley slopes toward a central permeable pavement section. Stormwater runoff flows off standard pavement into the permeable section, infiltrates vertically downward, and exits through an underdrain. The main treatment process consists of filtration through the permeable pavement media. Except as noted, a green alley follows

the design guidance provided in the Permeable Pavement Fact Sheet in the Urban Drainage and Flood Control District's (UDFCD) Urban Storm Drainage Criteria Manual, Volume 3 (USDCM Vol. 3). This fact sheet provides specific design guidance for the application of permeable pavement to a green alley. Detailed drawings and notes are provided at the back of this fact sheet to further illustrate the design of green alleys.

Figure 27 illustrates how permeable pavements can be integrated into a typical urban alley. The figure shows the basic elements of the green alley in cross section and in perspective.

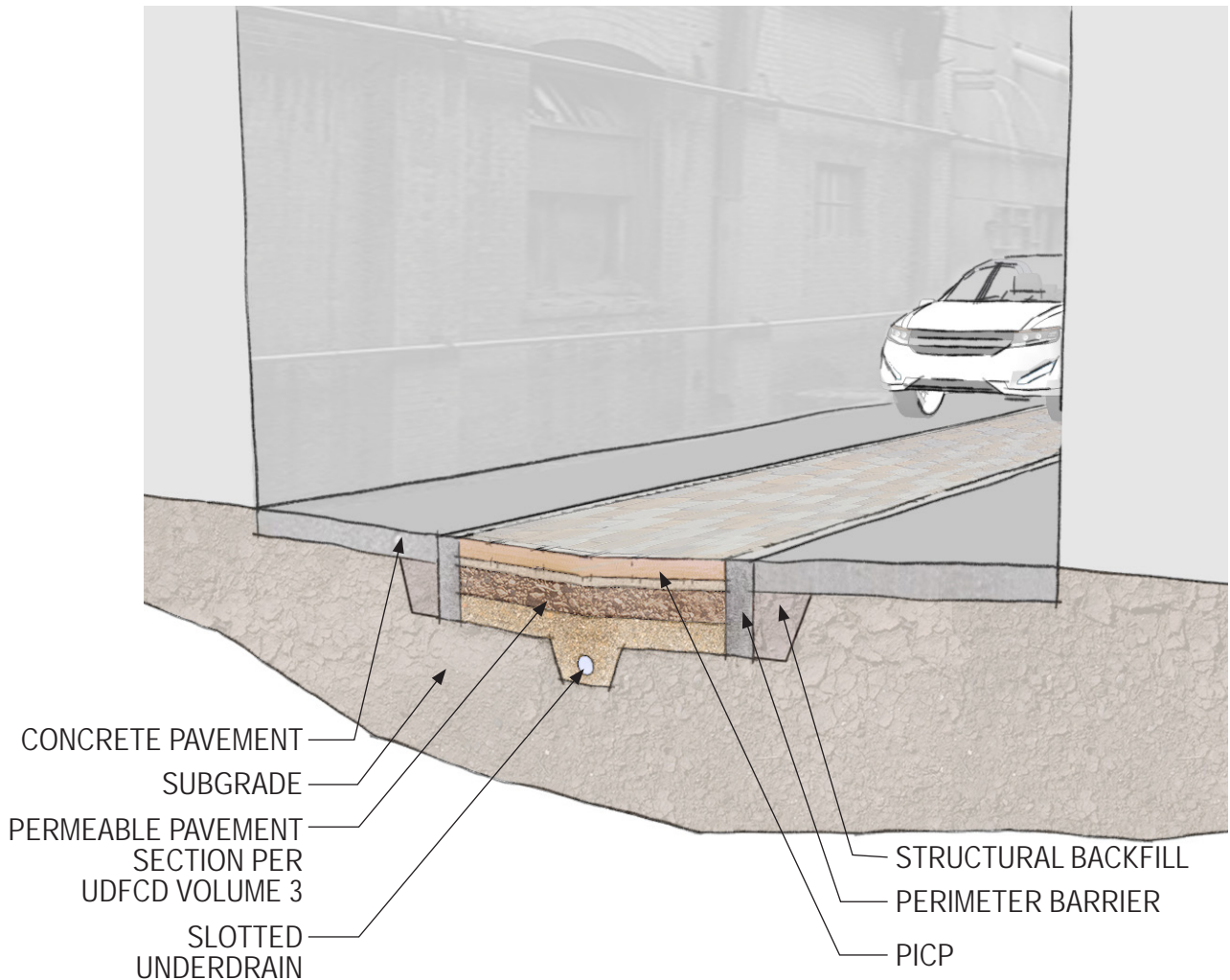

FIGURE 27. Green Alley  
(Source: Stream Design, 2015.)



## 7. GREEN ALLEY

### 7.2 USES AND RECOMMENDATIONS

When constructing a green alley, the permeable pavement typically is intended to run the full block length of the alley. Permeable pavement in the central third of the alley width can serve the water quality needs of the entire alley. Greater width would be necessary if portions of the adjacent buildings drain to the alley are intended to be treated.

A green alley should not be used in areas where hazardous materials are loaded, unloaded, or stored. Where other concerns regarding potential contamination (spill, groundwater, or soil) exist, the facility should be provided with an impermeable liner. In all cases, the outlet from the underdrain must be accessible by way of an inlet or manhole.

### 7.3 GREEN ALLEY AESTHETICS AND URBAN DESIGN

Green alleys can be important elements in the ultra-urban streetscape. The significant use of PICP in this BMP provides opportunities to greatly increase the attractiveness of alleys, making them appear more pedestrian friendly and less industrial. As with all improvements within the public right of way, green alleys should take a cue from existing district/neighborhood streetscape improvements, and where applicable, should use similar materials, colors, and textures to reinforce the cohesiveness of the urban context. All green alley improvements should meet Americans with Disabilities Act (ADA) guidelines, and be constructed with heavy duty materials and interlocking patterns to withstand AASHTO LRFD HL-93 (equivalent to HS-20) loading for heavy truck traffic common to most alleys.

### 7.4 GEOMETRY

The conceptual design details at the back of this fact sheet illustrate the geometry and design features of a green alley. The details are intended to provide a basis for the designer's final construction documents, although a site specific design will be necessary for addressing geotechnical issues, structural design, utility protection and relocation, tying in underdrain to a downstream storm drain or outfall, and associated final design and construction document preparation tasks.

### WIDTH

The width of PICP is based on the run-on ratio used for design. According to the design criteria of USDCM Volume 3, a ratio of 2 to 1 between upstream standard pavement and the PICP is recommended. However, in cases where rooftops drain to the alley, a run-on ratio including rooftops of up to 5 to 1 is acceptable.

### LENGTH

The length of permeable pavement is based on the desired portion of the alley to be treated, up to the full block length of the alley.

### PROFILE

The permeable pavement matches the longitudinal slope of the alley. In cross section, the alley is configured to drain to a central flow line within the permeable pavement.

### 7.5 DESIGN CRITERIA AND CONSIDERATIONS SIZING FOR WATER QUALITY

In keeping with the discussion on width, the size of the PICP is to be based on a run-on ratio including rooftops of up to 5 to 1. This is applied separately on each side of the flow line of the alley.

### UTILITIES

It is important to investigate existing and planned underground utilities and to avoid utility conflicts. It is also critical to understand the condition of existing utilities so that impacts that might be associated with the installation of the green alley improvements can be avoided or mitigated.

### OTHER COMPONENTS OF GREEN ALLEY DESIGN

Section 2.2 Design Criteria provides information regarding the following components of a green alley:

- underdrain system
- liner



## 7. GREEN ALLEY

### 7.6 GREEN ALLEY DETAILS

A typical design of a green alley is illustrated in a series of detail drawings in this section. The details indicate various elements of the green alley and representative dimensions. The designer is responsible for preparing final construction drawings suitable for the specific conditions, water quality requirements, utilities and constraints existing in the location where the BMP is to be sited. A geotechnical engineer shall consult on soil conditions and recommendations for lining. A structural engineer, with input from the geotechnical engineer shall design concrete elements, including wall thickness, reinforcing (reinforcing shown in details is representative only), any foundation components such as footings or bottom slab, and subgrade/bedding/backfill specifications. A site-specific design will also be necessary addressing utility protection and relocation, tying in underdrain to a downstream storm drain or outfall, and associated final design and construction document preparation tasks.

The following design notes apply to the detail drawings.

#### DESIGN NOTES

1. PICP AND UNDERLYING MATERIALS SHALL BE DESIGNED FOR HS-20 LOADING CONDITIONS AND SHALL MEET THE REQUIREMENTS OF USDCM VOLUME 3.
2. THE UNDERDRAIN SHALL MEET THE MATERIAL AND SLOT SPECIFICATIONS IDENTIFIED IN USDCM VOLUME 3.
3. FILTER MATERIAL SHALL MEET THE SPECIFICATIONS IDENTIFIED IN USDCM VOLUME 3. FILTER MATERIAL SHALL BE COMPACTED TO A DENSITY OF NOT LESS THAN 70 PERCENT OF RELATIVE DENSITY DETERMINED IN ACCORDANCE WITH ASTM D4253 AND D4254 (FOR FINES CONTENT LESS THAN 5 PERCENT).
4. THE UNDERDRAIN CLEANOUT SHALL CONSIST OF 4 INCH POLYVINYL CHLORIDE (PVC) PIPE WITH TWO 45 DEGREE BENDS AND A THREADED CAP SET 2 INCHES BELOW THE TOP OF THE PAVEMENT. PVC CLEANOUT SHOULD BE LOCATED IN A VALVE BOX SET WITHIN THE PICP AREA. FILTER MATERIAL SHOULD BE PLACED INSIDE THE VALVE BOX AROUND THE CLEANOUT. THE VALVE BOX SHALL HAVE A REMOVABLE PLATE OR GRATE FLUSH WITH PAVEMENT AND SHALL BE DESIGNED FOR HS-20 LOADING.
5. THE UNDERDRAIN OUTLET SHALL BE IN ACCORDANCE WITH THE USDCM VOLUME 3 PERMEABLE PAVEMENT SYSTEMS CRITERIA.
6. STRUCTURAL BACKFILL SHALL CONSIST OF CDOT CLASS 1 OR 2 STRUCTURE BACKFILL, AS DETERMINED BY ENGINEER AND COMPACTED TO AT LEAST 95 PERCENT OF MAXIMUM DENSITY IN ACCORDANCE WITH ASTM D698.
7. STRUCTURAL ENGINEER, WITH INPUT FROM GEOTECHNICAL ENGINEER, SHALL DESIGN WALL DIMENSIONS, REINFORCING, ANY FOUNDATION COMPONENTS SUCH AS FOOTINGS OR BOTTOM SLAB, AND SUBGRADE/BEDDING/BACKFILL SPECIFICATIONS.
8. COVER SHALL SUPPORT HS-20 LOADING AND CONSIST OF NEENAH R-4999 HEAVY DUTY BOLTED TRENCH GRATE TYPE D (SOLID) OR APPROVED EQUIVALENT – CATALOGUE NO. R-4999-HX FOR SPAN OF 2 FEET AND R-4999-MX FOR SPAN OF 3 FEET. THE LENGTH OF THE INLET COVER SHOULD BE FIELD CUT TO FIT OUTLET BOX.
9. LINER (IF SPECIFIED) SHALL BE A MINIMUM OF 30 MIL THICK PVC GEOMEMBRANE AND SHALL BE THERMALLY WELDED.





## 7. GREEN ALLEY

FIGURE 28. Green Alley Details  
(Source: Muller Engineering, 2015.)

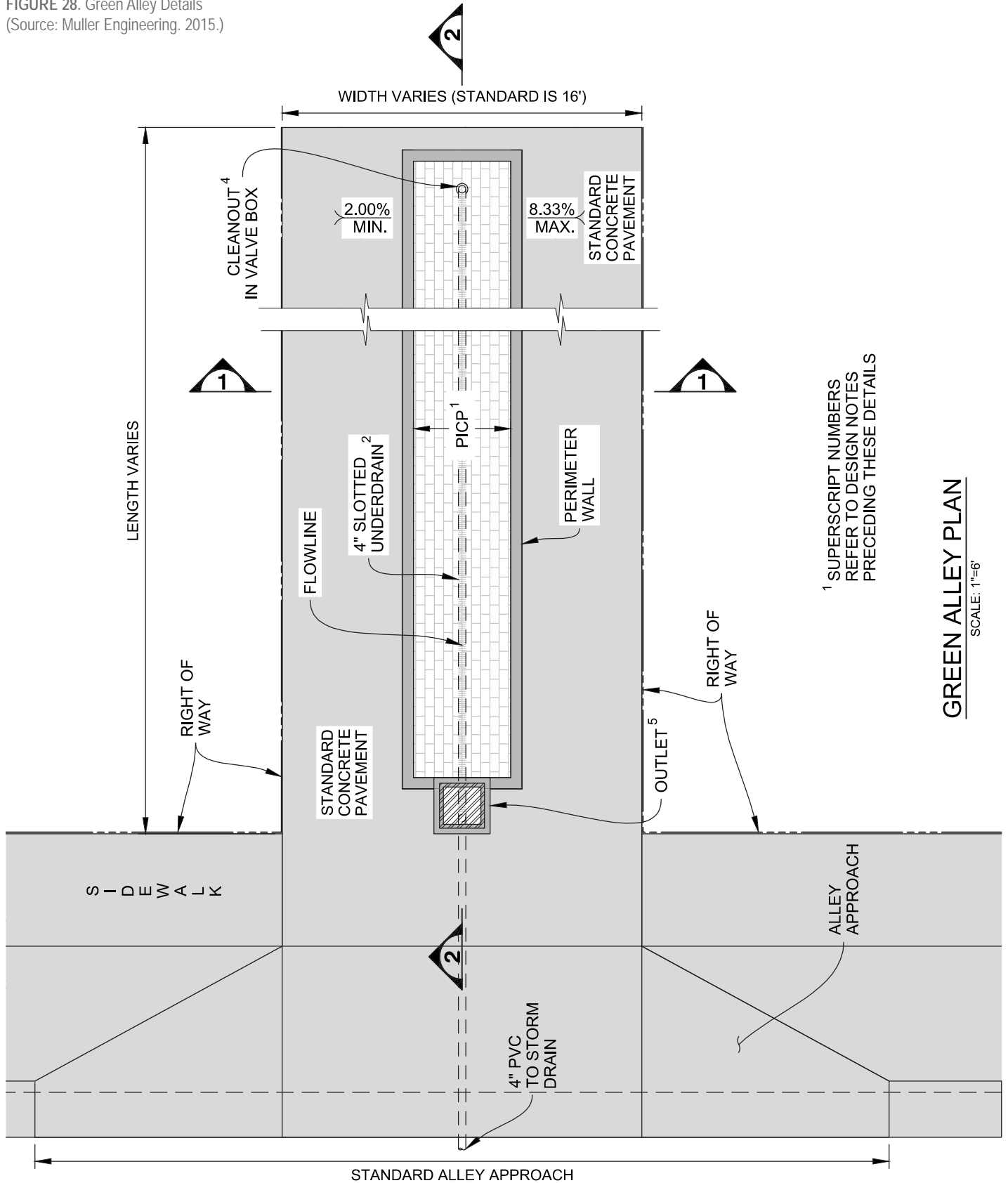

7. GREEN ALLEY

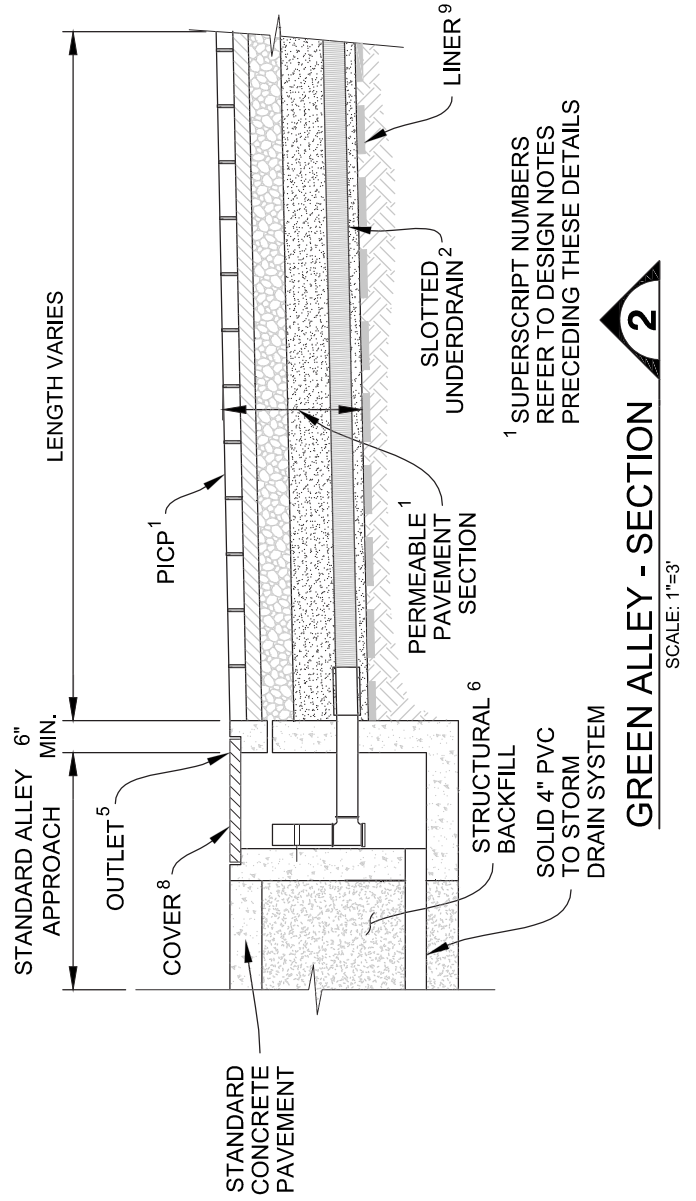
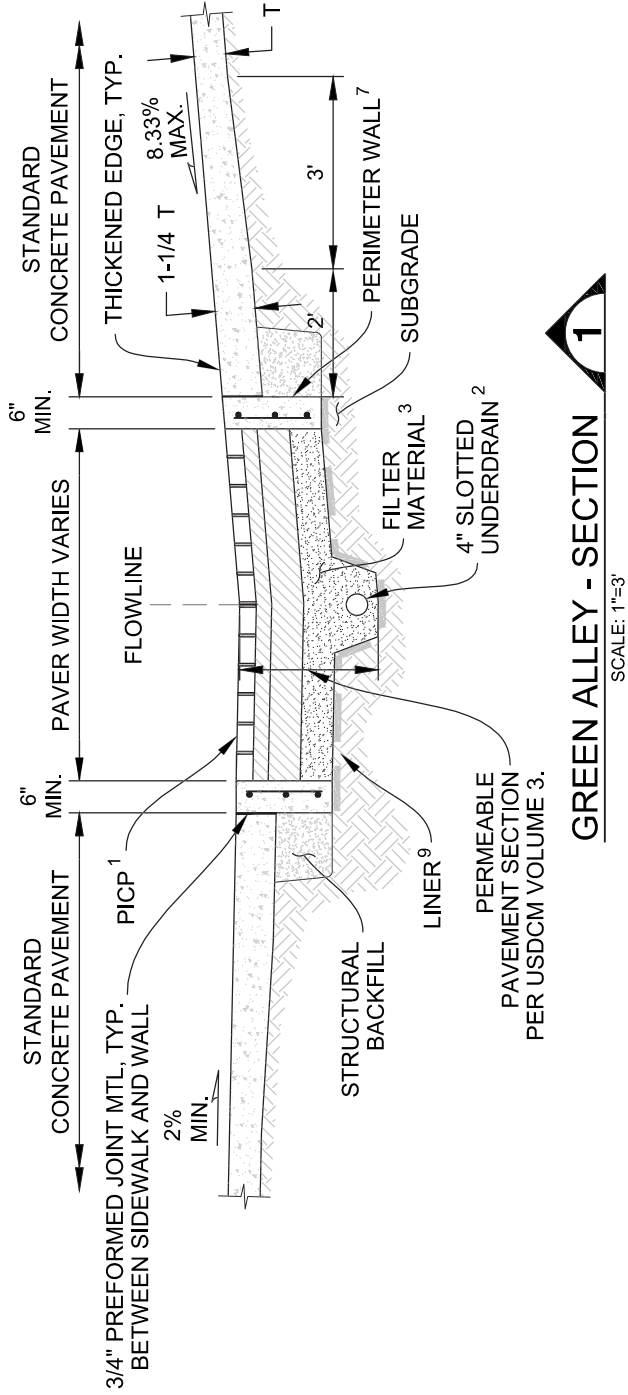

<sup>1</sup> SUPERScript NUMBERS REFER TO DESIGN NOTES PRECEDING THESE DETAILS

# 8. TREE TRENCH / PIT

## 8.1 DESCRIPTION

A tree trench is a type of bioretention facility located within street right-of-way (ROW) in the amenity zone between the street and the sidewalk. A tree trench that features a single tree is also called a tree pit. For the purposes of this fact sheet, it is assumed that multiple trees are included and so the terminology “tree trench” will generally be used. A tree trench provides water quality treatment of runoff from the street and adjacent pedestrian zone and may also be designed to treat runoff from adjacent private development. Stormwater runoff enters the tree trench through a curb opening and chase-type inlet, passes through a fine-gravel filter for pretreatment, is conveyed through an underdrain to one or more tree plantings, fills pore space around the tree roots, and exits

through a water level control structure. Treatment processes include filtration, absorption and adsorption, and uptake by the roots of the trees. This fact sheet provides specific design guidance for the application of bioretention to a tree trench, as described in Urban Drainage and Flood Control District's (UDFCD) Urban Storm Drainage Criteria Manual, Volume 3 (USDCM Vol. 3). Detailed drawings and notes are included in this fact sheet to further illustrate the design of tree trenches.

Figure 29 illustrates how a tree trench can be integrated into the amenity zone of a typical street section. The figure shows the basic elements of the tree trench in cross section and in perspective. Figure 30 provides a profile view of a tree trench.

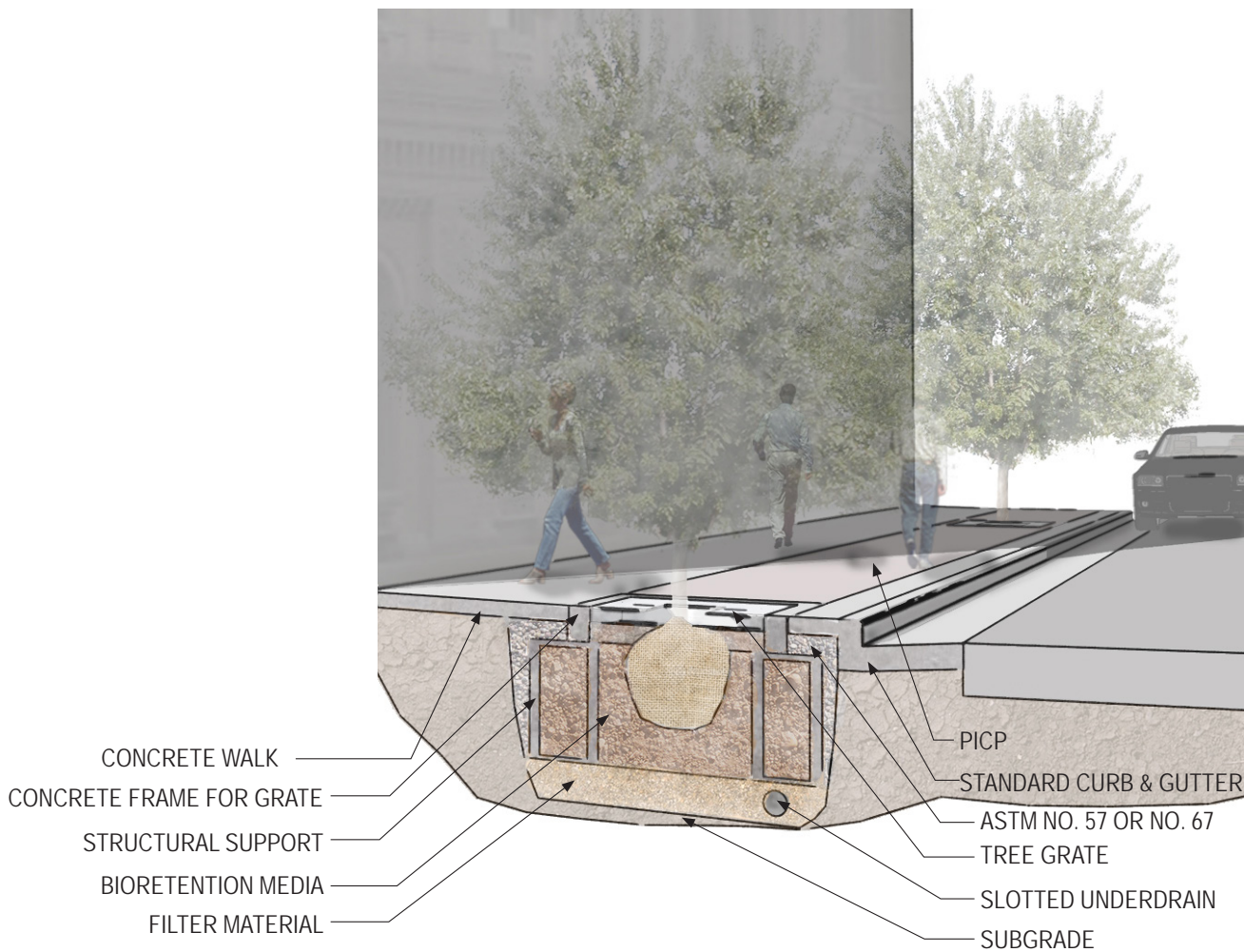

FIGURE 29. Tree Trench/Pit  
(Source: Stream Design. 2015.)



## 8. TREE TRENCH / PIT

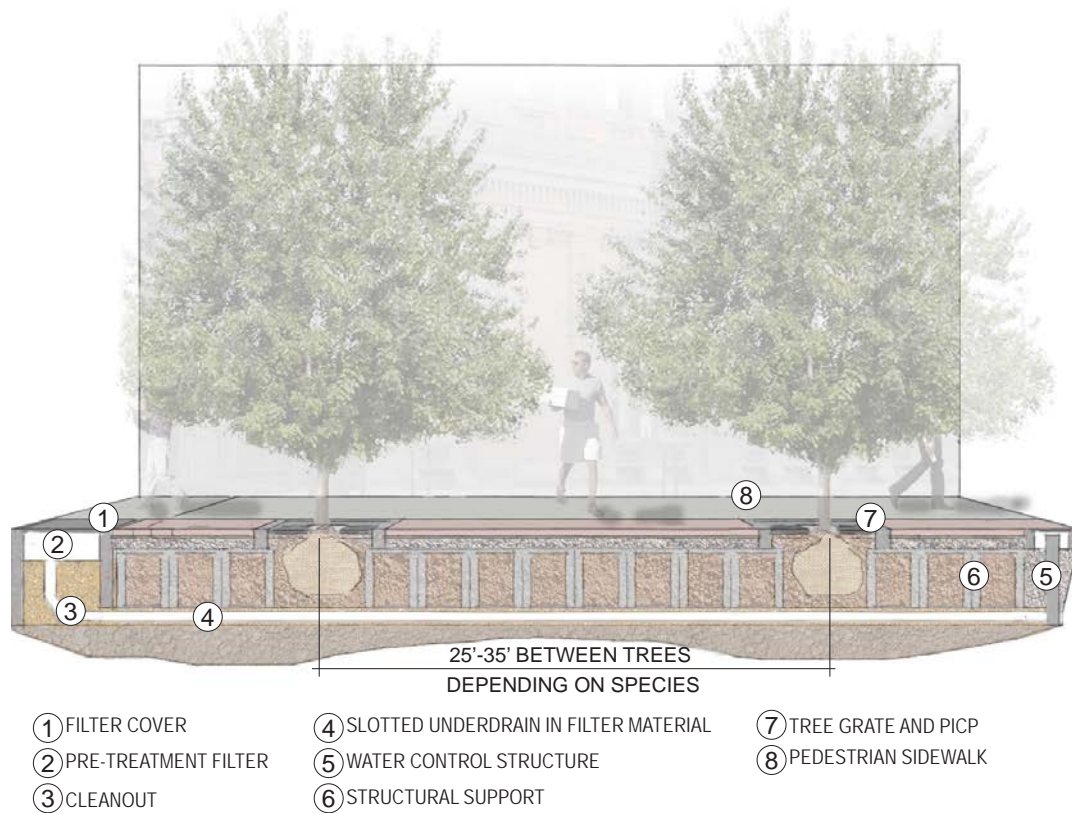

FIGURE 30 . Tree Trench/Pit Profile View (Source: Stream Design, 2015.)

### 8.2 USES AND RECOMMENDATIONS

Tree trenches can be used along streets that do not receive a deleterious amount of deicing salts and when they can be placed to receive adequate tributary area. Sizing and locating tree trenches requires a determination of the area draining to the tree trench. There is a specific drainage area associated with a certain size of tree trench and it is necessary to place the tree trench in a location that has this upstream area draining to it. As such, the upstream end of a block is generally not an effective place to install a tree trench, while the middle or downstream end of a block is usually conducive. Adjustments can be made to locations and tree trench sizes to arrive at a properly sized facility in a desirable location. Siting tree trenches is also influenced by the presence of a storm drain system; ideally, a nearby inlet or manhole provides a convenient location for discharge of the underdrain.

If serving just the public ROW (street and pedestrian zone), three tree trenches with three trees each can satisfy the water quality requirements for an impervious area measuring 400 feet (a typical city block) by 30 to 34 feet (street crown to ROW) for Denver's local and collector street classifications. If a portion of the adjacent private development is also served or the street has a significantly wider ROW, additional tree trenches would be necessary. Figure 31 illustrates the layout of tree trenches for the drainage area shown in orange. This requires three tree trenches with three trees each and is based on a street crown to ROW distance of 40 feet.

Other types of green infrastructure described in these fact sheets can be implemented in combination with tree trenches. Table 1 in the Introduction provides information on approximate drainage areas that can be treated by various types of green infrastructure BMPs.



## 8. TREE TRENCH / PIT

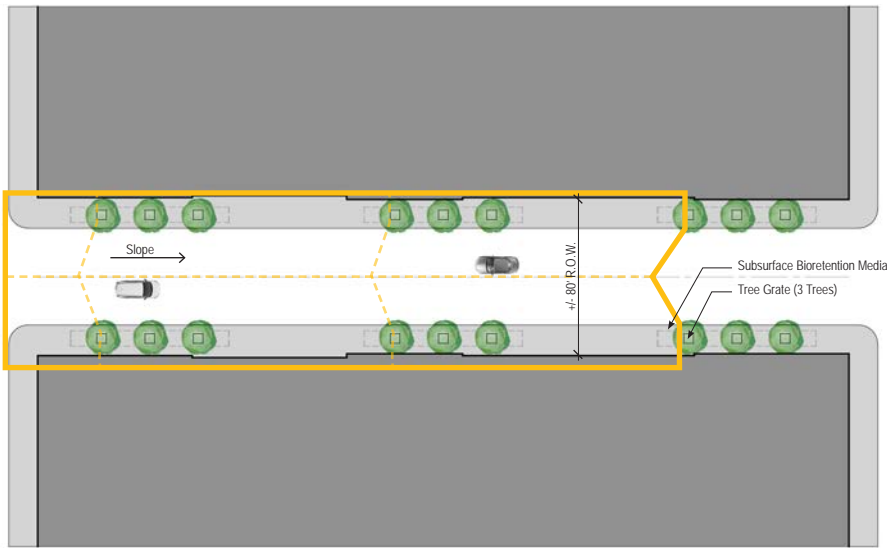

FIGURE 31 . Tree Trench/Pit City Block Diagram  
(Source: Stream Design. 2015.)



FIGURE 32 . Tree Trench/Pit in Urban Landscape  
(Source: Tetra Tech. 2015.)

### 8.3 TREE TRENCH/PIT AESTHETICS AND URBAN DESIGN

From an urban design perspective, tree trenches have the same applications as urban street tree plantings and can be used interchangeably. Trees are typically located 4 to 6 feet from the back of curb. The amenity strip in which the tree trench is located should be continuously paved with permeable pavement, contributing to an attractive urban environment by adding color and texture and providing an attractive counterpoint to the surrounding concrete paving. Permeable pavement in this location also benefits tree health by providing air and rainwater to the root system. As with any elements in the public ROW the visible components of tree trenches (grates and permeable pavement) should match or complement the larger urban context, as well as add value to the adjacent properties. Design detailing should be uniform within each block, and preferably, within each district or neighborhood. Figure 32 illustrates how tree trenches can be integrated into the urban landscape.

### 8.4 USE OF GRATES

The preferred treatment surrounding the tree is a 4 inch curb with no tree grate. This allows the soil surrounding the tree to be visible while protecting the soil from compaction. This

also allows for the area surrounding the tree to be planted with other vegetation. CCD staff has observed that trees surrounded by other vegetation are more frequently watered by nearby residents. Additionally, tree grates can damage the tree when not properly maintained.

When tree grates are used, a minimum separation of 4 inches between the grate and the tree trunk should be maintained. Grates shall be easily maintainable and need to be inspected on an annual basis. Another option is to use permeable interlocking concrete pavement (PICP) on top of the tree trench and continuing this to within 6 to 12 inches of the tree trunk. Examples of tree grates are shown in Figures 33-35. All designs should comply with the City of Denver Streetscape Design Manual, as well as the Public Works Transportation Standards and Details. In the event of conflicting criteria, these criteria supersede when constructing BMPs included in this manual. Cover plates meeting ADA accessibility requirements are necessary over the pre-treatment filter. The cover over the filter may consist of multiple sections that must be able to be lifted and slid to the side by maintenance staff to allow access to the filter media for cleaning. Additional information is provided in the design notes preceding the details.



## 8. TREE TRENCH / PIT



FIGURE 33. Tree Trench Example A (Source: Starburst tree grate unfinished. <http://www.ironsmith.cc/PROJECTS-TREEGRATES.html>. 2015)



FIGURE 34. Tree Trench Example B (Source: Glackin Thomas Panzack, Inc.)



FIGURE 35. Tree Trench Example C. (Source: Pervious Pavers over Silva Cells. <http://www.deeproot.com/blog/blog-entries/advantages-pf-using-pervious-pavers-over-silva-cells>. 2015.)

### 8.5 GEOMETRY

The conceptual design details at the back of this fact sheet illustrate the geometry and design features of a tree trench. The details are intended to provide a basis for the designer's final construction documents, although a site-specific design will be necessary addressing geotechnical issues, structural design, utility protection and relocation, tying in underdrain to a downstream storm drain or outfall, irrigation design, vegetation plan, and associated final design and construction document preparation tasks. Trees in this type of application require an uncompacted rooting volume of 750 to 1000 cubic feet per tree.

### WIDTH

The tree trench is typically centered approximately 4 to 6 feet behind the back of curb in a manner that preserves the step-out zone on the curb side of the trees and the sidewalk on the other. The width of excavation for the tree trench is approximately nine feet, and final tree planting areas must be a minimum of 5 feet in width.

Permeable pavement approximately 6 feet wide (as wide as the concrete grate rings) is recommended above the tree trench to intercept additional stormwater and help to provide oxygen to the roots of the tree.

### LENGTH

It is recommended that each tree trench section be constructed with a maximum of three trees with an overall tree trench length of about 66 to 86 feet, depending on tree spacing. Tree trench sections can be constructed back to back for any length desired; however, an inlet and water control structure is recommended for every three trees.



## 8. TREE TRENCH / PIT

### 8.6 TREE TRENCH / PIT DESIGN CONSIDERATION

#### WQCV ZONE

In accordance with USDCM Vol. 3 criteria for bioretention facilities, a tree trench is designed to capture the WQCV based on a 12-hour drain time. The required WQCV for the upstream area draining to a tree trench shall be computed using the procedures in USDCM Vol. 3.

In a departure from USDCM bioretention criteria, the water quality capture volume (WQCV) is comprised of the pore volume within the tree trench. A pore volume equivalent to 14 percent of the media and filter material volume can be counted toward the required WQCV in the ultra-urban green infrastructure BMPs documented in this manual. This pore space volume was selected based on testing of media approximately 24 hours after saturation. For the tree pit/ tree trench, this media porosity is reduced to an overall value of 13 percent to account for the volume occupied by the structural supports.

The available WQCV is calculated based on Equation 1, below:

#### Equation 1

WQCV provided =  $(D_{avg} * W_{avg} * L) * P$ , where

$D_{avg}$  = average depth of media below the elevation of the water control structure weir crest (wetted depth), ft

$W_{avg}$  = average media width, ft

$L$  = media length, ft

$P$  = media porosity = 0.13

For steep street slopes, the media depth below the water control structure weir crest may be substantially less at the upstream end of the tree trench than at the downstream end; this needs to be taken into account when estimating the average media depth below the weir crest. It is possible that for very steep streets and long tree trenches, the elevation of the water control structure weir crest may be below the bottom of the media at the upstream end of the tree trench; in this case the length of media below the weir crest must be adjusted to be less than the total length of the facility.

In addition to sizing a tree trench to contain the WQCV, a tree trench must be designed to capture the peak discharge expected during the water quality storm event, neglecting the backwater effects of the water control structure. This capacity is intended to allow the pore volume in the tree trench to fill. The peak discharge during the water quality event is to be calculated using the Rational Method as described in Section 2.2 Design Criteria.



## 8. TREE TRENCH / PIT

FIGURE 36. Pre-Treatment Filter Area based on Drainage Area

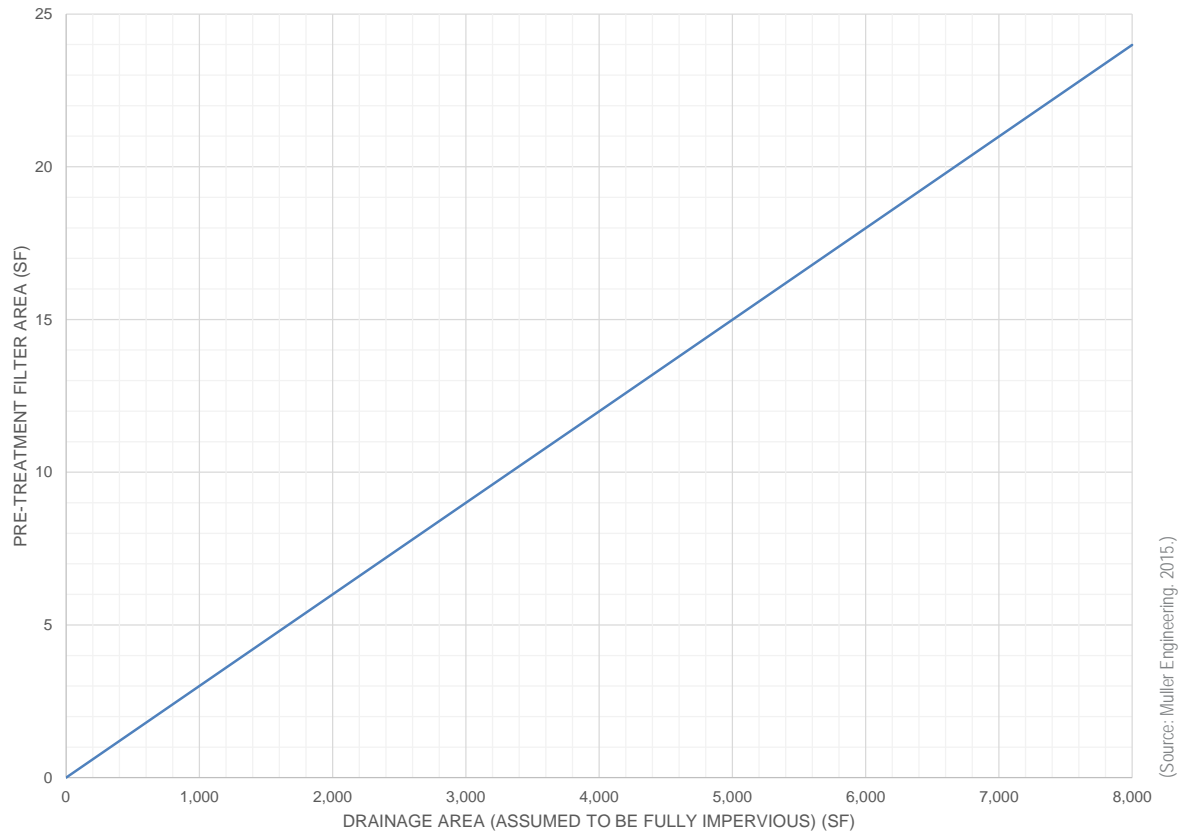

### INLET AND PRETREATMENT FILTER

The inlet must be designed to function in concert with a pretreatment filter. The pretreatment filter contains a filter media made up of ASTM No. 8 aggregate to provide a relatively high flow-through capacity. The filter is to be covered by removable grate panels meeting ADA requirements. Maintenance operations are necessary on a regular basis to remove litter, debris, and accumulated sediment. Figure 36 can be used to estimate the surface area of a pretreatment filter for a given upstream drainage area (assumed to be fully impervious). The details illustrate an inlet and filter combination in section. Additional information on inlet layout and sizing is provided in Section 2.2 Design Criteria.

### STRUCTURAL SUPPORTS

The tree trench relies on the placement of underground structural supports to provide a firm foundation for the permeable pavement, tree grates, and adjacent concrete pavement while at the same time keeping the bioretention media from becoming overly compacted. Dimensions and placement of these structural supports are represented in the details and a product description is provided in the Design Notes.

### OTHER PLANTER COMPONENTS

Section 2.2 Design Criteria section information regarding the following components of a tree trench:

- bioretention media
- underdrain system
- flow control structure
- liner





## 8. TREE TRENCH / PIT

### 8.7 VEGETATION GENERAL

Tree trenches are designed to provide a favorable growing environment for trees, and provide much more uncompacted soil and air space for healthy tree root development than typical for urban street trees. As such, a wide variety of trees should thrive in tree trenches. Designers should consult the Office of the City Forester's list of approved street trees for reference, provided in Appendix D. This resource also provides information on recommended tree spacing for different types of trees, which will vary between 25 and 35 feet in tree trenches as shown in the details. Grasses or perennials should not be planted above the root balls of trees, but are encouraged around the open soil perimeter.

### TREE FORM

When selecting shade trees for use in urban situations, designers should specify trees with strong central leaders that can be trained over time to branch out 6 feet high or higher to avoid creating barriers and hazards to pedestrians. Smaller ornamental trees (from approved list) may be planted in areas with overhead power lines, or potentially in areas with low pedestrian traffic, however these are not recommended in high pedestrian volume, ultra-urban conditions. Proposed trees in the city ROW must be approved by the Office of the City Forester and right-of-way tree planting permits are required.

### 8.8 TREE TRENCH / PIT DETAILS

Typical designs of a tree pit and a tree trench are illustrated in a series of detail drawings in this section. The details indicate various elements of the tree pit/trench and representative dimensions. The designer is responsible for preparing final construction drawings suitable for the specific conditions, water quality requirements, utilities and constraints existing in the location where the BMP is to be sited. A geotechnical engineer shall consult on soil conditions and recommendations for lining. A structural engineer, with input from the geotechnical engineer shall design concrete elements, including wall thickness,

reinforcing (reinforcing shown in details is representative only), any foundation components such as footings or bottom slab, and subgrade/bedding/backfill specifications. A site-specific design will also be necessary addressing utility protection and relocation, outlet of the underdrain to a downstream storm drain, selecting tree species, and associated final design and construction document preparation tasks. The following design notes apply to the detail drawings.



## 8. TREE TRENCH / PIT

### DESIGN NOTES

1. INLET WIDTH VARIES BASED ON UPSTREAM IMPERVIOUS AREA AND STREET SLOPE, WITH A MINIMUM WIDTH OF 2 FEET AND A MAXIMUM WIDTH OF 3 FEET. SEE CRITERIA FOR SIZING INLET WIDTH.
2. INLET COVER SHALL MEET ADA ACCESSIBILITY REQUIREMENTS AND CONSIST OF NEENAH R-4999 HEAVY DUTY BOLTED TRENCH GRATE TYPE D (SOLID) OR APPROVED EQUIVALENT – CATALOGUE NO. R-4999-HX FOR SPAN OF 2 FEET AND R-4999-MX FOR SPAN OF 3 FEET. THE LENGTH OF THE INLET COVER SHOULD BE FIELD CUT TO EXTEND CONTINUOUSLY FROM THE FACE OF CURB TO BACK OF PLANTER WALL AND SHOULD BE RECESSED FROM THE FACE OF THE CURB SO THAT THE CORNERS OF THE PLATE DO NOT PROTRUDE BEYOND THE TOP OF CURB.
3. FILTER COVER SHALL MEET ADA ACCESSIBILITY AND CONSIST OF NEENAH R-4999 HEAVY DUTY BOLTED TRENCH GRATE TYPE D (SOLID) OR APPROVED EQUIVALENT – CATALOGUE NO. R-4999-HX FOR SPAN OF 2 FEET, R-4999-MX FOR SPAN OF 3 FEET, AND R-4999- OX FOR SPAN OF 4 FEET. COVER MAY BE MADE UP OF SEPARATE PANELS AND EACH PANEL SHALL BE REMOVABLE. LENGTH AND WIDTH OF CONCRETE FILTER BOX SHALL BE ADJUSTED TO ALLOW STANDARD SIZE GRATES AND FRAME TO BE USED WHILE MAINTAINING REQUIRED SURFACE AREA. INDIVIDUAL GRATE SIZE SHALL BE NO GREATER THAN 8 SQUARE FEET.
4. FOR STREET SLOPES LESS THAN 5.5 PERCENT, THE ELEVATION OF THE FLOW LINE AT POINT A REPRESENTS THE WATER SURFACE ELEVATION ABOVE WHICH WATER IN THE INLET FILTER WOULD START TO FLOW OUT AND BE CONVEYED DOWN THE GUTTER. THIS ELEVATION IS EQUAL TO THE WATER QUALITY WATER SURFACE AND IS THE TOP OF THE WATER QUALITY CAPTURE VOLUME (WQCV).
5. FOR STREET SLOPES GREATER THAN 5.5 PERCENT, THE ELEVATION OF THE FLOW LINE AT POINT B REPRESENTS THE WATER SURFACE ELEVATION ABOVE WHICH WATER

- IN THE INLET FILTER WOULD START TO FLOW OUT AND BE CONVEYED DOWN THE GUTTER. THIS ELEVATION IS EQUAL TO THE WATER QUALITY WATER SURFACE AND IS THE TOP OF THE WATER QUALITY CAPTURE VOLUME.
6. THE PRE-TREATMENT FILTER SIZE IS TO BE SPECIFIED BY THE DESIGNER BASED ON THE MINIMUM SURFACE AREA SHOWN IN FIGURE 3. PRETREATMENT FILTER MEDIA SHALL BE ASTM NO. 8 AGGREGATE.
  7. THE WATER CONTROL STRUCTURE IS COMPRISED OF AN INLINE WATER LEVEL CONTROL STRUCTURE AS SHOWN IN THE DETAILS. THIS STRUCTURE HOUSES A CONTROL ORIFICE DESIGNED TO RELEASE THE WQCV IN 12 HOURS AND A WEIR SET WITHIN 2 INCHES BELOW TO 0 INCHES ABOVE THE WATER QUALITY WATER SURFACE. THE WATER CONTROL STRUCTURE SHALL BE AN AGRI DRAIN  
INLINE WATER LEVEL CONTROL STRUCTURE AS MANUFACTURED BY AGRI DRAIN CORPORATION, OR APPROVED EQUIVALENT.
  8. THE UNDERDRAIN SHALL MEET THE MATERIAL AND SLOT SPECIFICATIONS IDENTIFIED IN USDCM VOLUME 3.
  9. THE TREE GRATE, WHEN USED, IS TO BE SPECIFIED BY THE DESIGNER AND MAY NEED TO CONSIDER LOCAL AREA DESIGN GUIDELINES IF APPLICABLE.
  10. THE WATER QUALITY WATER SURFACE IS THE TOP OF THE WQCV AND IS EQUAL TO THE ELEVATION OF THE WEIR CREST OF THE WATER CONTROL STRUCTURE (6 TO 8 INCHES BELOW THE ELEVATION OF THE SIDEWALK AT THE WATER CONTROL STRUCTURE). THE WQCV IS COMPRISED OF THE PORE VOLUME OF THE MEDIA BELOW THE WATER QUALITY WATER SURFACE BASED ON AN OVERALL POROSITY OF 13 PERCENT (ACCOUNTS FOR VOLUME OCCUPIED BY STRUCTURAL SUPPORTS). IN ADDITION, SIZING OF TREE TRENCH IS BASED ON PROVIDING A FLOW-THROUGH CAPACITY THROUGH THE PRE-TREATMENT FILTER AND UNDERDRAIN AT LEAST AS GREAT AS THE PEAK DISCHARGE OF THE WATER QUALITY EVENT (NEGLECTING THE BACKWATER



## 8. TREE TRENCH / PIT

EFFECTS OF THE WATER CONTROL STRUCTURE.

11. BIORETENTION MEDIA SHALL MEET THE SPECIFICATIONS IDENTIFIED IN THE DESIGN CRITERIA SECTION OF THE INTRODUCTION. THE ROOTBALL SHALL BE PLACED ON NATIVE SOIL OR BIORETENTION MEDIA, AS SPECIFIED BY DESIGNER, COMPACTED TO 85 TO 90 PERCENT OF MAXIMUM DENSITY IN ACCORDANCE WITH ASTM D698 TO REDUCE THE LIKELIHOOD OF SETTLEMENT UNDER THE TREE.
12. GEOGRID SHOWN ON DETAILS SHALL BE BX1100 AS MANUFACTURED BY TENSAR INTERNATIONAL CORPORATION, INC. OR APPROVED EQUIVALENT. AN ADDITIONAL LAYER OF MICROGRID AS MANUFACTURED BY STRATA SYSTEMS SHALL BE PLACED ON TOP OF THE HORIZONTAL LAYER OF GEOGRID ON THE TOP OF THE STRUCTURAL SUPPORTS AND BELOW THE LAYER OF ASTM NO. 2 AGGREGATE.
13. FILTER MATERIAL SHALL MEET THE SPECIFICATIONS IDENTIFIED IN USDCM VOLUME 3. FILTER MATERIAL SHALL BE COMPACTED TO A DENSITY OF NOT LESS THAN 70 PERCENT OF RELATIVE DENSITY DETERMINED IN ACCORDANCE WITH ASTM D4253 AND D4254 (FOR FINES CONTENT LESS THAN 5 PERCENT). THE UNDERDRAIN CLEANOUT SHALL CONSIST OF 4 INCH POLYVINYL CHLORIDE (PVC) PIPE WITH TWO 45 DEGREE BENDS AND A THREADED CAP SET 2 INCHES ABOVE THE TOP OF THE BIORETENTION MEDIA. A REMOVABLE PLATE OR GRATE FLUSH WITH PAVEMENT SHALL BE PROVIDED ABOVE THE CLEANOUT.
14. CDOT CLASS 1 OR 2 STRUCTURE BACKFILL, AS DETERMINED BY ENGINEER AND COMPACTED TO AT LEAST 95 PERCENT OF MAXIMUM DENSITY IN ACCORDANCE WITH ASTM D698.
15. PICP AND UNDERLYING MATERIALS SHALL MEET THE REQUIREMENTS OF USDCM VOLUME 3.
16. LINER AS SPECIFIED BY GEOTECHNICAL ENGINEER SHALL BE MINIMUM 30 MIL THICK PVC GEOMEMBRANE FABRICATED IN ONE PIECE.
17. STRUCTURAL SUPPORTS SHALL BE SILVA CELL 2 AS MANUFACTURED BY DEEPROOT GREEN INFRASTRUCTURE OR APPROVED EQUIVALENT, INSTALLED ACCORDING TO MANUFACTURER'S RECOMMENDATIONS.
18. STRUCTURAL ENGINEER, WITH INPUT FROM GEOTECHNICAL ENGINEER, SHALL DESIGN WALL DIMENSIONS, REINFORCING, ANY FOUNDATION COMPONENTS SUCH AS FOOTINGS OR BOTTOM SLAB, AND SUBGRADE/BEDDING/BACKFILL SPECIFICATIONS.
19. TREES SHALL BE STAKED WITH THREE GUY LINES. GUY LINES SHALL BE FASTENED TO TREE GRATE OR TO EYEBOLTS INSTALLED IN CONCRETE TREE RING.





8. TREE TRENCH / PIT

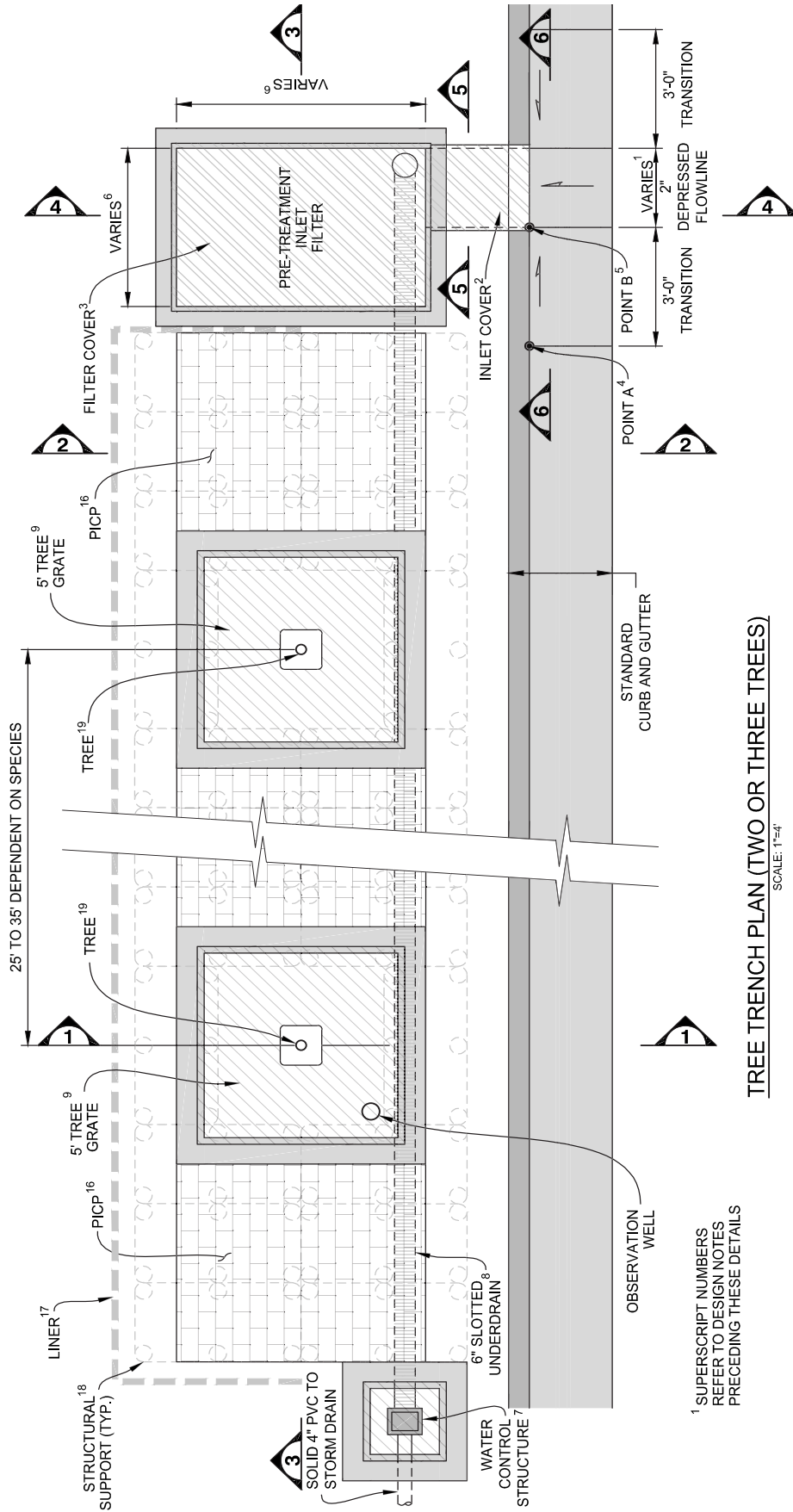

TREE TRENCH PLAN (TWO OR THREE TREES)

SCALE: 1"=4'

<sup>1</sup> SUPERScript NUMBERS REFER TO DESIGN NOTES PRECEDING THESE DETAILS

8. TREE TRENCH / PIT

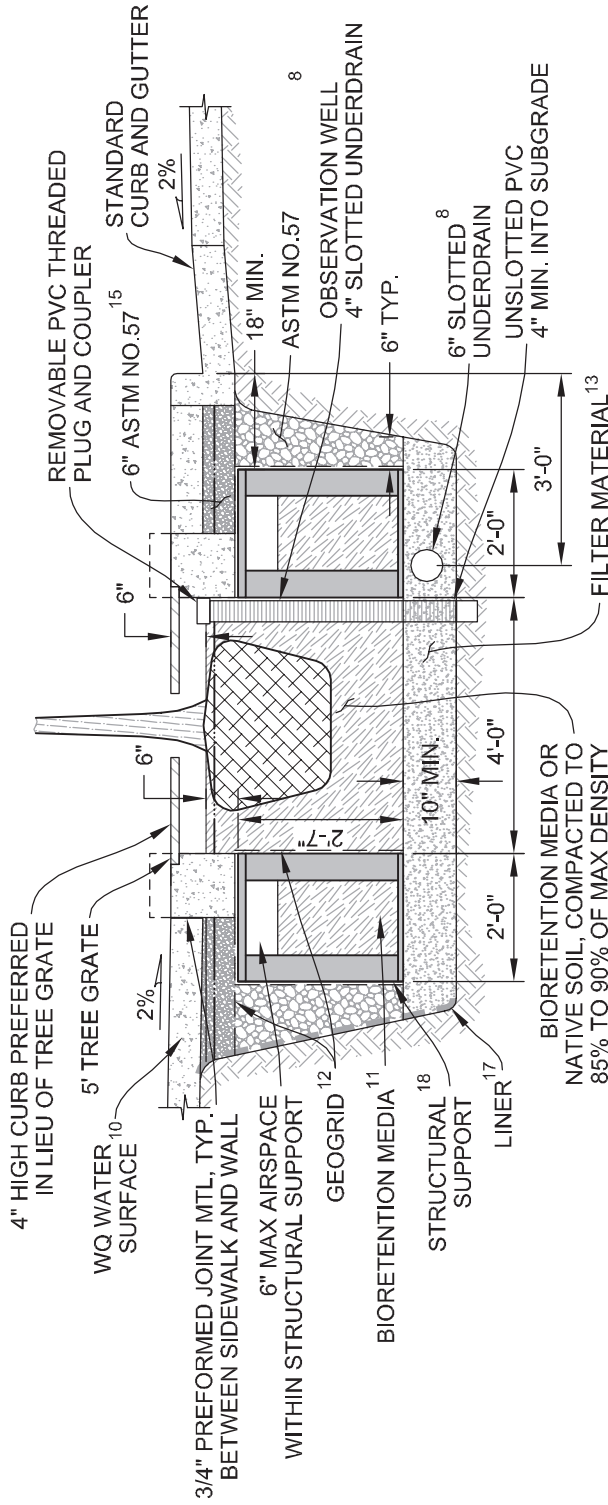

TREE TRENCH / PIT - SECTION 1

SCALE: 1"=3'

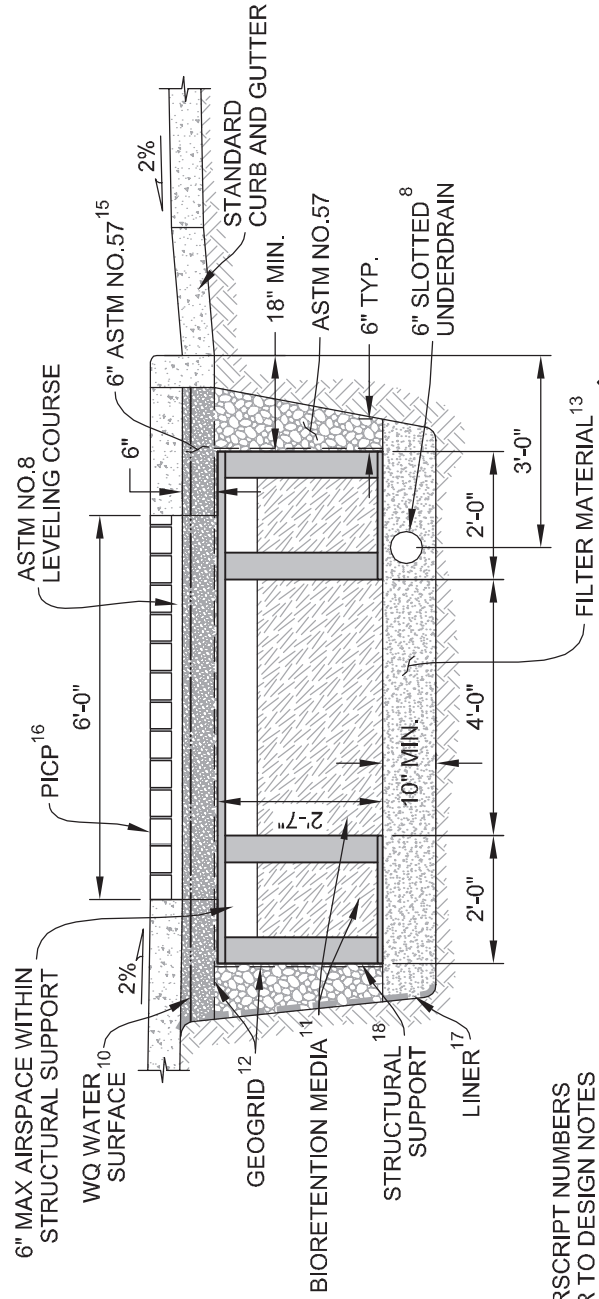

TREE TRENCH / PIT - SECTION 2

SCALE: 1"=3'

<sup>1</sup> SUPERScript NUMBERS REFER TO DESIGN NOTES PRECEDING THESE DETAILS

# 8. TREE TRENCH / PIT

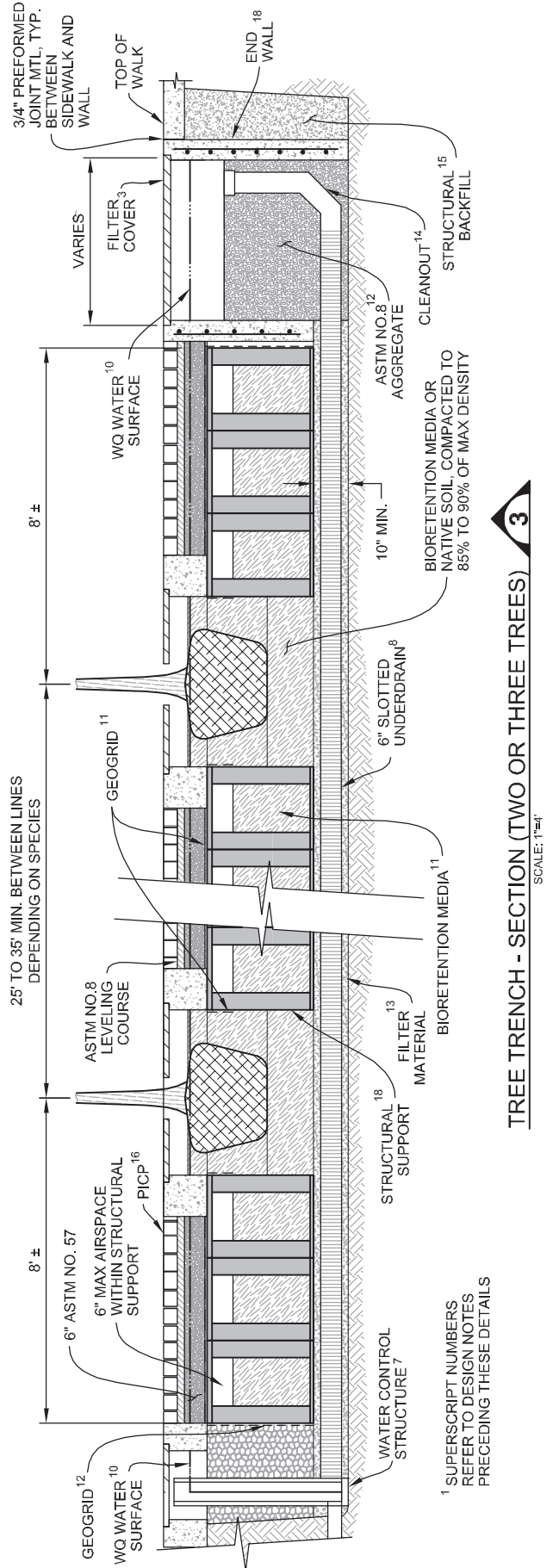
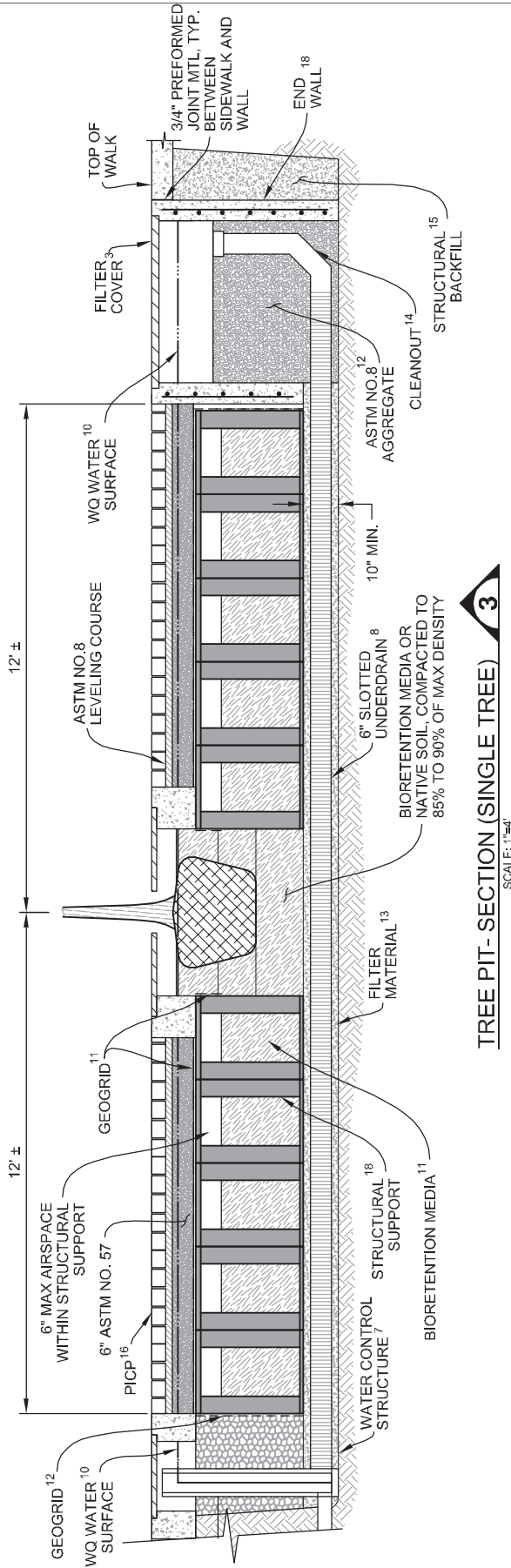

<sup>1</sup> SUPERSCRIPT NUMBERS REFER TO DESIGN NOTES PRECEDING THESE DETAILS

8. TREE TRENCH / PIT

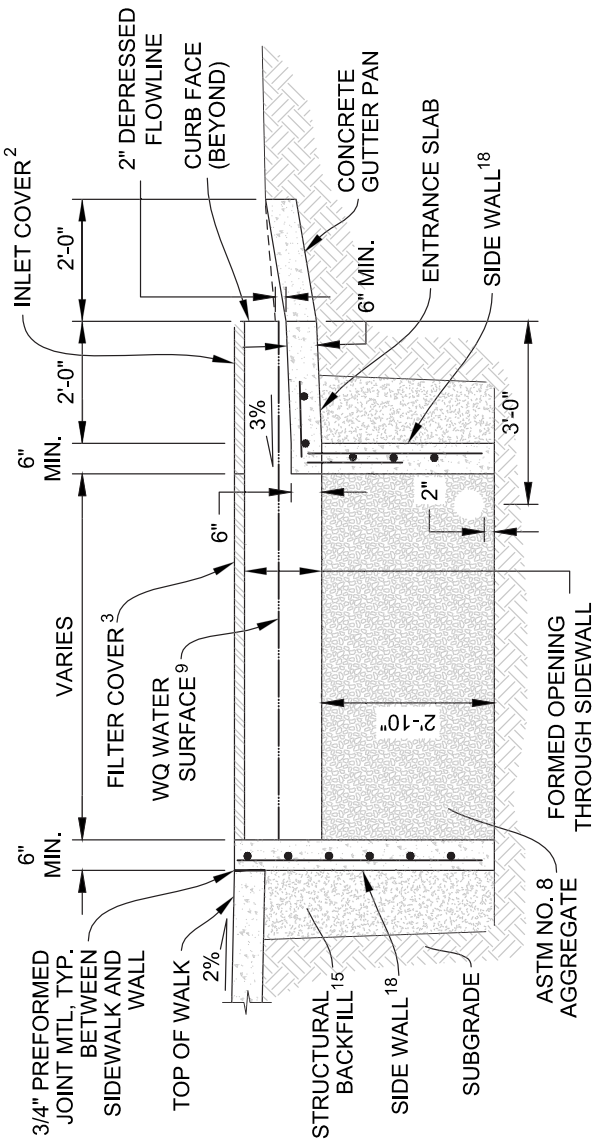

**TREE TRENCH / PIT - SECTION 4**

SCALE: 1"=3'

<sup>1</sup> SUPERScript NUMBERS REFER TO DESIGN NOTES PRECEDING THESE DETAILS

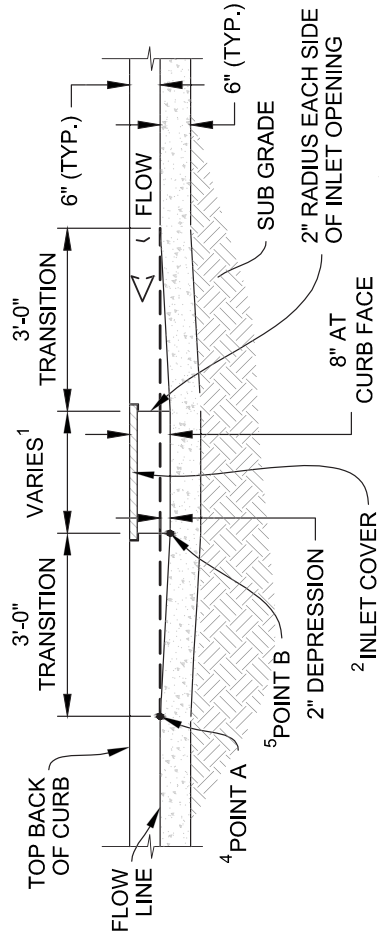

**TREE TRENCH / PIT SECTION 6**

SCALE: 1"=3'

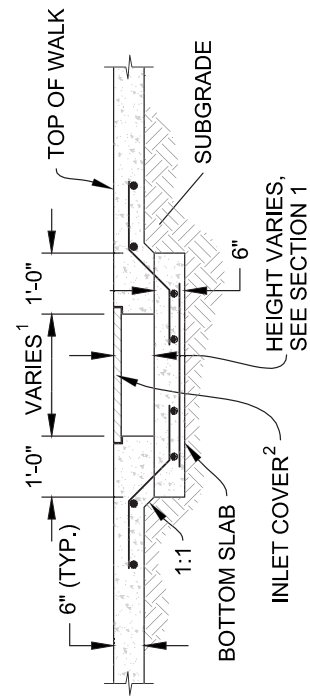

**TREE TRENCH / PIT - SECTION 5**

SCALE: 1"=3'



8. TREE TRENCH / PIT

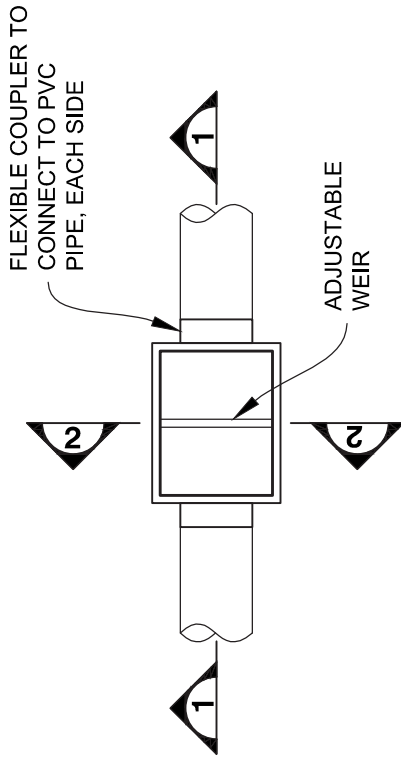

WATER CONTROL STRUCTURE - PLAN  
SCALE: 1"=1'

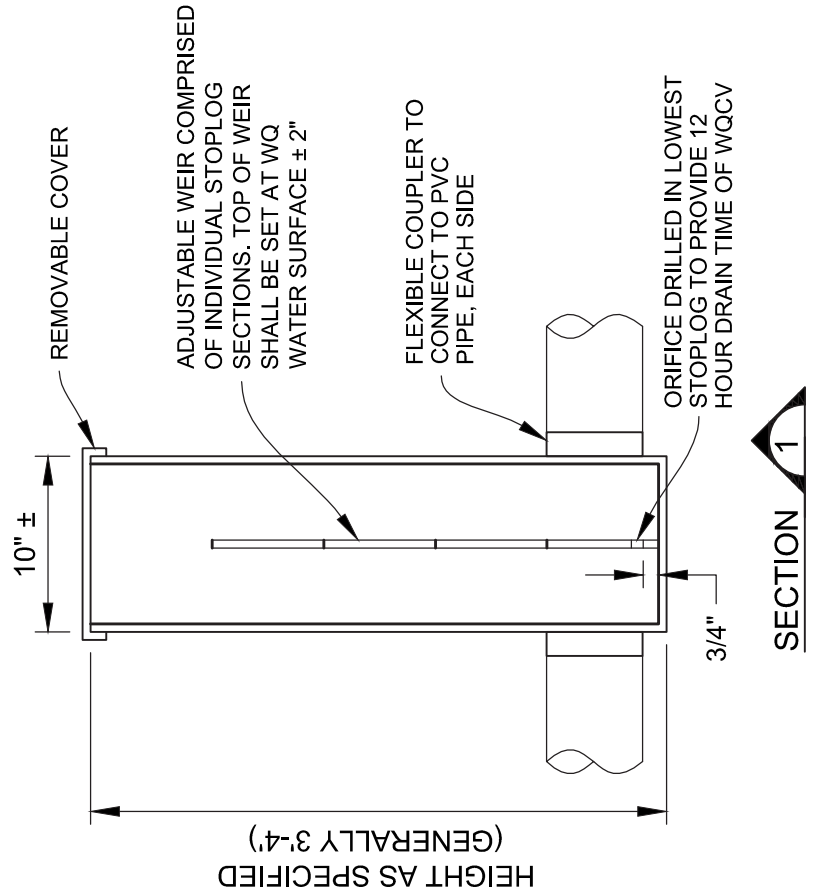
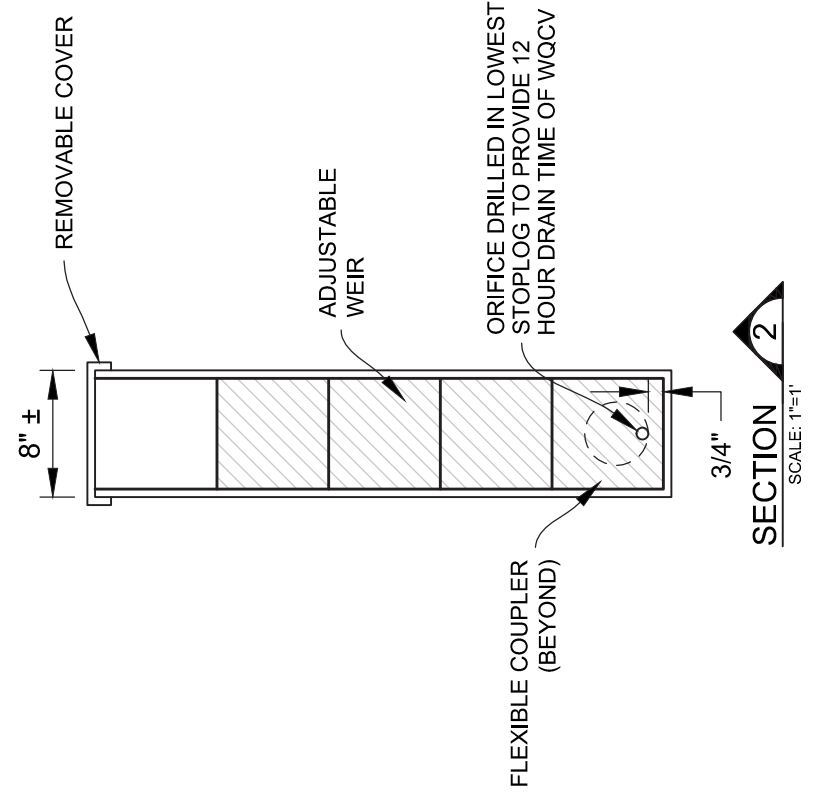

# APPENDIX A: DEVELOPMENT REVIEW CHECKLISTS

This section presents an overview of basic components every project development plan containing green infrastructure should incorporate. These components help identify items that would be helpful for City Staff performing the plan review for green infrastructure designs.

## BASIC COMPONENTS

- Vicinity map showing project boundary, adjacent streets and nearby hydrologic features (streams, reservoirs, etc.) and FEMA floodplain delineations (if applicable), and depth to groundwater (if applicable).
- Total project area within the site boundary in acres or square feet.
- Description of existing site drainage, including conveyance network; discharge locations, size, and capacity for each discharge point; contributing drainage area and design flow; and off-site drainage areas, design flows, and locations.
- Description of proposed project site drainage including conveyance network; discharge locations, size, and capacity for each discharge point; contributing drainage area and design flow; and off-site drainage areas, design flows, and locations.
- Increase or decrease in impervious area in the proposed condition as compared to the pre-project condition.
- Total planned impervious area within the site boundary, expressed in acres or square feet and as a percentage of the total project area.
- Receiving waters to which the project site discharges, whether the waters are listed as impaired on the EPA-approved 303(d) list, or if an EPA-approved TMDL applies to the waterbodies.
- Identification and description of all source control measures implemented on the project site.
- Sizing calculation for each proposed practice, including water quality design flow, design volume, outlet design, overflow design, drawdown, ponding depth, etc.
- Map or source identifying justification for rainfall data selection.
- Studies or findings from environmental conditions reports within project area.

## PLAN SHEET COMPONENTS

- Vicinity map showing project boundary, adjacent streets and nearby hydrologic features (streams, reservoirs, etc.).
- Mapped FEMA floodplain limits in relation to the project site, if applicable.
- Locations where off-site drainage enters the project site, if applicable.
- The total planned impervious area within the site boundary.
- Details regarding the proposed project site drainage network, including storm drains, concrete channels, swales, detention facilities, stormwater treatment facilities, natural and constructed channels, and the method for conveying off-site flows through or around the proposed project.
- All discharge locations from the proposed project site with appropriately sized energy dissipation, if applicable.
- Areas within the site designated for preservation, such as stream corridors, open space, coarse sediment areas, and other natural resources.
- Areas of high infiltration potential.

## APPENDIX A: DEVELOPMENT REVIEW CHECKLISTS

- Details of planned slope protection measures to improve geotechnical stability and mitigate potential erosion.
- Downspout disconnections with standard detail.
- Areas of active landscaping that will require irrigation.
- Invert elevation and opening width for curb cuts.
- Invert elevation and overflow elevation for each identified treatment control, flow control practice, and low-flow diversion practice.
- Invert elevation and outlet elevation for each pretreatment facility, if applicable.
- Sufficient grading details so that runoff is properly directed to the design inflow location.

### **SPECIFIC GREEN INFRASTRUCTURE DESIGN COMPONENTS**

Successful construction, effectiveness and long-term operation of green infrastructure are a result of sound design and engineering. Design components are specific to green infrastructure type, volume of runoff treated, and intended removal efficiency (if applicable). The design must satisfy applicable local regulatory requirements. In Denver, green infrastructure design specifications are outlined in the USDCM Volume 3. The checklists presented in Appendix A, B, and C for three green infrastructure types (bioretention, tree trenches/pits, and permeable pavement) are intended to provide guidance to development plan reviewers to determine whether design requirements are met. The checklists should be used in combination with the USDCM Volume 3, which provides more detailed design specifications and calculations.

## APPENDIX A: DEVELOPMENT REVIEW CHECKLISTS

### DEVELOPMENT PLAN REVIEW CHECKLIST FOR BIORETENTION

#### Bioretention: Streetside Stormwater Planters, Bumpout Stormwater Planters, and Green Gutters

Bioretention is an engineered, depressed landscape area designed to capture and filter or infiltrate the water quality capture volume (WQCV). Bioretention areas typically consist of a flow regulating structure, a pretreatment element, an engineered soil mix planting bed, vegetation, and an outflow regulating structure. Bioretention areas are designed to hold and remove stormwater pollutants through a variety of chemical, physical and biological processes in a manner similar to natural ecosystems. Bioretention systems are flexible, adaptable and versatile stormwater management facilities that can fit readily into parking lot islands, street medians, residential, commercial and industrial campus landscaping, and urban and suburban green spaces and corridors. Bioretention is a type of green infrastructure that can be configured as streetside stormwater planters, bumpout stormwater planters, and green gutters to fit in ultra-urban settings. Technical guidance is provided in green text below, including references to the Urban Drainage and Flood Control District (UDFCD) Urban Storm Drainage Criteria Manual Volume 3, which is available online at [www.udfcd.org](http://www.udfcd.org).

#### Plan Review Checklist for Bioretention

Questions	Yes	No	N/A	Notes
<b>Site Applicability and Considerations</b>				
<b>Siting</b>				
Is the site location and size reasonable for the drainage area to be treated?	<input type="checkbox"/>	<input type="checkbox"/>	<input type="checkbox"/>	
Have utilities been located? Do any utilities need to be relocated?	<input type="checkbox"/>	<input type="checkbox"/>	<input type="checkbox"/>	
Is the practice installed at the downstream end of the block, if possible?	<input type="checkbox"/>	<input type="checkbox"/>	<input type="checkbox"/>	
Is there a nearby inlet or manhole that would provide a convenient location to discharge the underdrain to?	<input type="checkbox"/>	<input type="checkbox"/>	<input type="checkbox"/>	
<b>Pedestrian Considerations</b>				
Is the site location and size reasonable for the drainage area to be treated? For example, a green gutter is appropriate for treating runoff from public ROW only; inclusion of runoff from adjacent development would require a stormwater planter.	<input type="checkbox"/>	<input type="checkbox"/>	<input type="checkbox"/>	
Maximum depth of bioretention does not exceed 20 inches.	<input type="checkbox"/>	<input type="checkbox"/>	<input type="checkbox"/>	
Are access paths a minimum of 4 feet wide and in compliance with ADA design guidelines?	<input type="checkbox"/>	<input type="checkbox"/>	<input type="checkbox"/>	
Are step-out zones appropriately sized between the curb and bioretention per City and County of Denver requirements? (This requirement is not applicable to green gutters).	<input type="checkbox"/>	<input type="checkbox"/>	<input type="checkbox"/>	
<b>Geometry</b>				
Is the bioretention no longer than 40 feet?	<input type="checkbox"/>	<input type="checkbox"/>	<input type="checkbox"/>	
Is the top of the bioretention horizontal in longitudinal profile, regardless of street slope?	<input type="checkbox"/>	<input type="checkbox"/>	<input type="checkbox"/>	

## APPENDIX A: DEVELOPMENT REVIEW CHECKLISTS

Questions	Yes	No	N/A	Notes
<b>Other</b>				
Was a soil investigation performed by a registered geologist, soil scientist, or professional engineer?	<input type="checkbox"/>	<input type="checkbox"/>	<input type="checkbox"/>	
Were recommendations in a geotechnical report followed?	<input type="checkbox"/>	<input type="checkbox"/>	<input type="checkbox"/>	
Is there positive drainage away from adjacent buildings at all locations?	<input type="checkbox"/>	<input type="checkbox"/>	<input type="checkbox"/>	
<b>Design Considerations</b>				
<b>WQCV Zone</b>				
Does the design allow for the recommended storage volume (above the surface) per USDCM Volume 3?	<input type="checkbox"/>	<input type="checkbox"/>	<input type="checkbox"/>	
Does the design filter area (bottom surface of facility) meet or exceed the minimum calculated filter area per USDCM Volume 3?	<input type="checkbox"/>	<input type="checkbox"/>	<input type="checkbox"/>	
<b>Inlet and Outlet Controls</b>				
Is the inlet sized to convey the water quality event assuming an appropriate amount of debris blockage (i.e., debris factor)?	<input type="checkbox"/>	<input type="checkbox"/>	<input type="checkbox"/>	
Were recommendations in a geotechnical report followed?	<input type="checkbox"/>	<input type="checkbox"/>	<input type="checkbox"/>	
Is the outlet control orifice sized to drain the design volume in 12 hours or more and is a minimum orifice size of 3/8-inch used (to avoid clogging)?	<input type="checkbox"/>	<input type="checkbox"/>	<input type="checkbox"/>	
<b>Pretreatment</b>				
Is pretreatment provided (forebay in conjunction with the inlet)?	<input type="checkbox"/>	<input type="checkbox"/>	<input type="checkbox"/>	
Does pretreatment allow for sediment deposition without bypass of the practice and is this clearly detailed in section on the plans?	<input type="checkbox"/>	<input type="checkbox"/>	<input type="checkbox"/>	
<b>Underdrain System</b>				
Does the facility design include an underdrain system (recommended)? An underdrain system may be necessary if infiltration tests show percolation drawdown rates slower than two times the rate needed to drain the WQCV over 12 hours, or where required to divert water away from structures as determined by a professional engineer.	<input type="checkbox"/>	<input type="checkbox"/>	<input type="checkbox"/>	
Do all references to the underdrain clearly call for slotted pipe (not perforated) and are the slot widths included in the plan?	<input type="checkbox"/>	<input type="checkbox"/>	<input type="checkbox"/>	
Are cleanouts provided to enable underdrain inspection and maintenance?	<input type="checkbox"/>	<input type="checkbox"/>	<input type="checkbox"/>	

APPENDIX A: DEVELOPMENT REVIEW CHECKLISTS

Questions	Yes	No	N/A	Notes
Is the underdrain system placed within a section of CDOT Class C filter material (not bioretention media) and is this material specified on the plans?	<input type="checkbox"/>	<input type="checkbox"/>	<input type="checkbox"/>	
Do the plans specifically state that no geotextile fabric shall be placed between the underdrain and the filter material or between the filter material and the bioretention media?	<input type="checkbox"/>	<input type="checkbox"/>	<input type="checkbox"/>	
<b>Walls and Spillway</b>				
Are subgrade conditions necessary to ensure suitable foundation for the walls and reduce potential settling specified?	<input type="checkbox"/>	<input type="checkbox"/>	<input type="checkbox"/>	
Does the design provide an outlet or other means of overflow (spillway) at the elevation of maximum ponding depth?	<input type="checkbox"/>	<input type="checkbox"/>	<input type="checkbox"/>	
<b>Impermeable Liners</b>				
If a liner is not required, is the facility at least 10 feet away from any structure?	<input type="checkbox"/>	<input type="checkbox"/>	<input type="checkbox"/>	
<p>If a liner is required, are the following conditions met:</p> <ul style="list-style-type: none"> <li>• Are subgrade conditions necessary to ensure suitable foundation for the walls and reduce potential settling specified?</li> <li>• Is a 30 mil (minimum) PVC liner installed on the bottom and sides of the basin, extending up at least to the top of the underdrain layer?</li> <li>• Does the liner have a minimum of 9 inches of cover over the membrane to protect the membrane from UV deterioration?</li> <li>• Is the attachment of the liner to a solid reinforced concrete wall detailed on the plans?</li> <li>• Do the plans call for heat welding and testing of all seams and specify to contact the engineer to be present during testing of all seams?</li> <li>• Does the liner meet the physical requirements presented in Table B-5 of the USDCM Volume 3?</li> </ul>	<input type="checkbox"/>	<input type="checkbox"/>	<input type="checkbox"/>	
<b>Bioretention Media and Vegetation</b>				
For bioretention media, is a minimum of 18 inches of growing medium provided to support the establishment of vegetation roots?	<input type="checkbox"/>	<input type="checkbox"/>	<input type="checkbox"/>	
If trees are to be installed, is the filter media depth at least 2 feet? (3 to 4 feet recommended)	<input type="checkbox"/>	<input type="checkbox"/>	<input type="checkbox"/>	

APPENDIX A: DEVELOPMENT REVIEW CHECKLISTS

Questions	Yes	No	N/A	Notes
Is the identified growing medium per Volume 3 requirements for bioretention structures and is this clearly referred to as bioretention media (not “growing media”) in all locations referenced?	<input type="checkbox"/>	<input type="checkbox"/>	<input type="checkbox"/>	
Is the bioretention media specified on the plans?	<input type="checkbox"/>	<input type="checkbox"/>	<input type="checkbox"/>	
Does the design incorporate drought tolerant vegetation that thrives in sandy soil and non-invasive?	<input type="checkbox"/>	<input type="checkbox"/>	<input type="checkbox"/>	
<b>Additional Comments</b>				

APPENDIX A: DEVELOPMENT REVIEW CHECKLISTS

**DEVELOPMENT PLAN REVIEW CHECKLIST FOR TREE TRENCH / PIT**

A tree trench provides stormwater quality treatment for streets and adjacent pedestrian zones. Stormwater enters the tree trench through a curb opening, passes through a pea gravel filter for pretreatment and is conveyed through an underdrain to one or more tree plantings. Treatment processes include filtration, soil adsorption, and uptake by the roots of the trees. A tree trench that features a single tree is called a tree pit. Technical guidance is provided in green text below. Note that the Urban Drainage and Flood Control District (UDFCD) Urban Storm Drainage Criteria Manual Volume 3 does not contain a practice description for infiltration trenches. Specifications on this Plan Review Checklist were obtained from the Colorado Department of Transportation's Drainage Design Manual (see (<http://www.coloradodot.info/programs/environmental/water-quality/documents/drainage-design-manual>)).

Plan Review Checklist for Tree Trench / Pit

Questions	Yes	No	N/A	Notes
<b>Site Applicability and Considerations</b>				
<b>Siting</b>				
Are the trees sited in the amenity zone between the step-out zone and sidewalk?	<input type="checkbox"/>	<input type="checkbox"/>	<input type="checkbox"/>	
Are the trees sited in a manner that preserves sidewalk width and will not hinder high pedestrian traffic?	<input type="checkbox"/>	<input type="checkbox"/>	<input type="checkbox"/>	
Are City and County of Denver requirements for step-out zones followed and appropriately considered when adjacent parking exists and does not exist?	<input type="checkbox"/>	<input type="checkbox"/>	<input type="checkbox"/>	
Is the bottom of the tree trench at least five feet above the seasonal high water table or bedrock?	<input type="checkbox"/>	<input type="checkbox"/>	<input type="checkbox"/>	
Is there a nearby inlet or manhole that would provide a convenient location to discharge the underdrain to?	<input type="checkbox"/>	<input type="checkbox"/>	<input type="checkbox"/>	
<b>Pedestrian Considerations</b>				
Are tree grates or paver grates designed to meet ADA requirements?	<input type="checkbox"/>	<input type="checkbox"/>	<input type="checkbox"/>	
Will the pretreatment filter and inlet be covered by removable or accessible grate panels meeting ADA requirements?	<input type="checkbox"/>	<input type="checkbox"/>	<input type="checkbox"/>	
<b>Geometry</b>				
Tree trench sections do not have more than three trees.	<input type="checkbox"/>	<input type="checkbox"/>	<input type="checkbox"/>	
<b>Other</b>				
Was a soil investigation performed by a registered geologist, soil scientist, or professional engineer?	<input type="checkbox"/>	<input type="checkbox"/>	<input type="checkbox"/>	
Were recommendations in a geotechnical report followed?	<input type="checkbox"/>	<input type="checkbox"/>	<input type="checkbox"/>	
Is there positive drainage away from adjacent buildings at all locations?	<input type="checkbox"/>	<input type="checkbox"/>	<input type="checkbox"/>	



APPENDIX A: DEVELOPMENT REVIEW CHECKLISTS

Questions	Yes	No	N/A	Notes
<b>Design Considerations</b>				
<b>WQCV zone</b>				
Does the design allow for the recommended storage volume (above the surface) per USDCM Volume 3?	<input type="checkbox"/>	<input type="checkbox"/>	<input type="checkbox"/>	
Is the tree trench designed as a flow-through system to provide equal to or greater capacity than peak discharge during the water quality storm event?	<input type="checkbox"/>	<input type="checkbox"/>	<input type="checkbox"/>	
<b>Inlet and Outlet Controls</b>				
Is an inlet and water control structure provided for every trench section (or every three trees)?	<input type="checkbox"/>	<input type="checkbox"/>	<input type="checkbox"/>	
Will the street inlet be located at the upstream end of the tree trench?	<input type="checkbox"/>	<input type="checkbox"/>	<input type="checkbox"/>	
Will the inlet convey runoff from the curb and gutter and across the step-out zone?	<input type="checkbox"/>	<input type="checkbox"/>	<input type="checkbox"/>	
Is the inlet sized to convey the water quality event assuming an appropriate amount of debris blockage (i.e., debris factor)?	<input type="checkbox"/>	<input type="checkbox"/>	<input type="checkbox"/>	
Is the tree trench designed as a flow-through system to provide equal to or greater capacity than peak discharge during the water quality storm event?	<input type="checkbox"/>	<input type="checkbox"/>	<input type="checkbox"/>	
Does the outlet control structure provide an adjustable control weir to assist with the wetting of the structural media and tree roots?	<input type="checkbox"/>	<input type="checkbox"/>	<input type="checkbox"/>	
Is an observation well/clean out provided? CDOT recommends an observation well of 100-150 mm perforated PVC pipe.	<input type="checkbox"/>	<input type="checkbox"/>	<input type="checkbox"/>	
<b>Pretreatment</b>				
Is pretreatment provided (forebay in conjunction with the inlet)?	<input type="checkbox"/>	<input type="checkbox"/>	<input type="checkbox"/>	
Is the pretreatment filter designed with media (e.g. pea gravel) that allows for relatively high-flow through capacity?	<input type="checkbox"/>	<input type="checkbox"/>	<input type="checkbox"/>	
Is the sizing of the pre-treatment filter based on an infiltration rate of 4 inches per minute?	<input type="checkbox"/>	<input type="checkbox"/>	<input type="checkbox"/>	
<b>Underdrain System</b>				
Does the facility design include an underdrain system (recommended)? An underdrain system may be necessary if infiltration tests show percolation drawdown rates slower than two times the rate needed to drain the WQCV over 12 hours, or where required to divert water away from structures as determined by a professional engineer.	<input type="checkbox"/>	<input type="checkbox"/>	<input type="checkbox"/>	

APPENDIX A: DEVELOPMENT REVIEW CHECKLISTS

Questions	Yes	No	N/A	Notes
Is the underdrain system designed to meet the capacity required to convey the peak discharge of the water quality event?	<input type="checkbox"/>	<input type="checkbox"/>	<input type="checkbox"/>	
Do all references to the underdrain clearly call for slotted pipe (not perforated) and are the slot widths included in the plan?	<input type="checkbox"/>	<input type="checkbox"/>	<input type="checkbox"/>	
Are cleanouts provided to enable underdrain inspection and maintenance?	<input type="checkbox"/>	<input type="checkbox"/>	<input type="checkbox"/>	
Is the underdrain system placed within a section of CDOT Class C filter material (not bioretention media) and is this material specified on the plans?	<input type="checkbox"/>	<input type="checkbox"/>	<input type="checkbox"/>	
Do the plans specifically state that no geotextile fabric shall be placed between the underdrain and the filter material or between the filter material and the bioretention media?	<input type="checkbox"/>	<input type="checkbox"/>	<input type="checkbox"/>	
<b>Impermeable Liners</b>				
Is a liner required? (if yes, select the type below) <input type="checkbox"/> One trench sidewall <input type="checkbox"/> Both trench sidewalls <input type="checkbox"/> Fully lined installation (constraints on tree root system are expected and considered in tree selection)	<input type="checkbox"/>	<input type="checkbox"/>	<input type="checkbox"/>	
If a liner is required, are the following requirements met: <ul style="list-style-type: none"> <li>• Is a 30 mil (minimum) PVC liner installed on the bottom and sides of the basin, extending up at least to the top of the underdrain layer?</li> <li>• Does the liner have a minimum of 9 inches of cover over the membrane to protect the membrane from UV deterioration?</li> <li>• Is the attachment of the liner to a solid reinforced concrete wall detailed on the plans?</li> <li>• Do the plans call for heat welding and testing of all seams and specify to contact the engineer to be present during testing of all seams?</li> <li>• Does the liner meet the physical requirements presented in Table B-5 of the USDCM Volume 3.</li> </ul>	<input type="checkbox"/>	<input type="checkbox"/>	<input type="checkbox"/>	
<b>Bioretention Media and Vegetation</b>				
Is the bioretention media (placed above the root ball and in structural media) consistent with the criteria outlined in the Bioretention Section in USDCM Volume 3 and specified on all plans?	<input type="checkbox"/>	<input type="checkbox"/>	<input type="checkbox"/>	

APPENDIX A: DEVELOPMENT REVIEW CHECKLISTS

Questions	Yes	No	N/A	Notes
Is the structural media composition supportive of tree growth and tree grate and pavers? (one part bioretention media with two parts 1-1/2 inch crushed gravel is recommended)	<input type="checkbox"/>	<input type="checkbox"/>	<input type="checkbox"/>	
Is the total bioretention media and structural media depth at least 2 feet? (3 to 4 feet recommended)	<input type="checkbox"/>	<input type="checkbox"/>	<input type="checkbox"/>	
Are cleanouts provided to enable underdrain inspection and maintenance?	<input type="checkbox"/>	<input type="checkbox"/>	<input type="checkbox"/>	
Are appropriate trees and tree spacing used per Office of the City's Forester list of approved street trees?	<input type="checkbox"/>	<input type="checkbox"/>	<input type="checkbox"/>	
If magnesium chloride de-icer is used on the streets adjacent to a proposed tree trench, will trees with a tolerance to saline soils be planted?	<input type="checkbox"/>	<input type="checkbox"/>	<input type="checkbox"/>	
If shade trees are used, are trees with strong central leaders that can be trained over time to branch out 6 feet high or higher used to avoid creating barriers and hazards to pedestrians?	<input type="checkbox"/>	<input type="checkbox"/>	<input type="checkbox"/>	
In areas with overhead powerlines, has the height of the tree been considered?	<input type="checkbox"/>	<input type="checkbox"/>	<input type="checkbox"/>	
<b>Additional Comments</b>				

## APPENDIX A: DEVELOPMENT REVIEW CHECKLISTS

### DEVELOPMENT PLAN REVIEW CHECKLIST FOR PERMEABLE PAVEMENT

Permeable pavement allows streets, parking lots, sidewalks, and other impervious covers to maintain their structural and functional features while restoring natural infiltration capacity. Permeable pavement contains small voids that allow rainfall and runoff to drain through the pavement and eventually into the underlying soils. It can be used at various sites with low traffic frequency such as parking lots, sidewalks, and driveways. Many permeable pavement surfaces are available, including pervious concrete, porous asphalt and permeable interlocking concrete pavers. A green alley is designed to provide water quality treatment and infiltration of runoff through the use of permeable pavement. The following plan review checklist is intended for reviewing green alleys where permeable pavement is the primary green infrastructure reviewed. Green alleys may include other green infrastructure applications. Technical guidance is provided in green text below, including references to the Urban Drainage and Flood Control District (UDFCD) Urban Storm Drainage Criteria Manual Volume 3, which is available online at [www.udfcd.org](http://www.udfcd.org).

#### Plan Review Checklist for Permeable Pavement

Questions	Yes	No	N/A	Notes
<b>Site Applicability and Considerations</b>				
<b>Siting</b>				
Has the appropriate application of pervious pavement (e.g., use, traffic loading, slopes) been considered? Permeable pavement is not appropriate for runoff from erosive areas such as steep slopes and/or areas of sparse vegetation where sediment-laden runoff could clog the system.	<input type="checkbox"/>	<input type="checkbox"/>	<input type="checkbox"/>	
Is there a nearby inlet or manhole that would provide a convenient location to discharge the underdrain to?	<input type="checkbox"/>	<input type="checkbox"/>	<input type="checkbox"/>	
<b>Pedestrian Considerations</b>				
Does the design meet ADA guidelines?	<input type="checkbox"/>	<input type="checkbox"/>	<input type="checkbox"/>	
Is the permeable surface constructed with the most heavy duty materials and interlocking patterns to withstand the heavy truck traffic common to most alleys?	<input type="checkbox"/>	<input type="checkbox"/>	<input type="checkbox"/>	
<b>Geometry</b>				
Is the minimum width of permeable pavement equal to one third of the alley width?	<input type="checkbox"/>	<input type="checkbox"/>	<input type="checkbox"/>	
Is the permeable pavement the central flow line of the alley? The longitudinal slope should match the alley's gradient.	<input type="checkbox"/>	<input type="checkbox"/>	<input type="checkbox"/>	
<b>Other</b>				
Was a soil investigation performed by a registered geologist, soil scientist, or professional engineer?	<input type="checkbox"/>	<input type="checkbox"/>	<input type="checkbox"/>	
Were recommendations in a geotechnical report followed?	<input type="checkbox"/>	<input type="checkbox"/>	<input type="checkbox"/>	
Is there positive drainage away from adjacent buildings at all locations?	<input type="checkbox"/>	<input type="checkbox"/>	<input type="checkbox"/>	
<b>Design Considerations</b>				
Is the ratio of upstream impervious area to permeable pavement area 2:1 (as recommended in USDCM Volume 3)?	<input type="checkbox"/>	<input type="checkbox"/>	<input type="checkbox"/>	

## APPENDIX A: DEVELOPMENT REVIEW CHECKLISTS

Questions	Yes	No	N/A	Notes
Is a perimeter barrier installed where appropriate and detailed in section based on permeable pavement type?	<input type="checkbox"/>	<input type="checkbox"/>	<input type="checkbox"/>	
Does the design include an observation well to monitor drain time of the pavement system over time?	<input type="checkbox"/>	<input type="checkbox"/>	<input type="checkbox"/>	
<b>Underdrain System and Filter Material</b>				
Does the facility design include an underdrain system (recommended)? An underdrain system may be necessary if infiltration tests show percolation drawdown rates slower than two times the rate needed to drain the WQCV over 12 hours, or where required to divert water away from structures as determined by a professional engineer.	<input type="checkbox"/>	<input type="checkbox"/>	<input type="checkbox"/>	
Do all references to the underdrain clearly call for slotted pipe (not perforated) and are the slot widths included in the plan?	<input type="checkbox"/>	<input type="checkbox"/>	<input type="checkbox"/>	
Are cleanouts provided to enable underdrain inspection and maintenance?	<input type="checkbox"/>	<input type="checkbox"/>	<input type="checkbox"/>	
Is the underdrain system placed within a section of CDOT Class C filter material (not bioretention media) and is this material specified on the plans?	<input type="checkbox"/>	<input type="checkbox"/>	<input type="checkbox"/>	
Do the plans specifically state that no geotextile fabric shall be placed between the underdrain and the filter material or between the filter material and the bioretention media?	<input type="checkbox"/>	<input type="checkbox"/>	<input type="checkbox"/>	
Does the design section provide specific and appropriate filter layer details?	<input type="checkbox"/>	<input type="checkbox"/>	<input type="checkbox"/>	
<b>Impermeable Liners</b>				
If a liner is required, are the following conditions met:				
• Is a 30 mil (minimum) PVC liner installed on the bottom and sides of the basin, extending up at least to the top of the underdrain layer?	<input type="checkbox"/>	<input type="checkbox"/>	<input type="checkbox"/>	
• Does the liner have a minimum of 9 inches of cover over the membrane to protect the membrane from UV deterioration?	<input type="checkbox"/>	<input type="checkbox"/>	<input type="checkbox"/>	
• Is the attachment of the liner to a solid reinforced concrete wall detailed on the plans?	<input type="checkbox"/>	<input type="checkbox"/>	<input type="checkbox"/>	
• Do the plans call for heat welding and testing of all seams and specify to contact the engineer to be present during testing of all seams?	<input type="checkbox"/>	<input type="checkbox"/>	<input type="checkbox"/>	
• Does the liner meet the physical requirements presented in Table B-5 of the USDCM Volume 3.	<input type="checkbox"/>	<input type="checkbox"/>	<input type="checkbox"/>	

## APPENDIX A: DEVELOPMENT REVIEW CHECKLISTS

Questions	Yes	No	N/A	Notes
If a liner is not required, do subgrade soils have a minimum infiltration rate of 2 times the rate needed to drain the WQCV over 12 hours?	<input type="checkbox"/>	<input type="checkbox"/>	<input type="checkbox"/>	
Additional Comments				

# APPENDIX B: INSPECTION & MAINTENANCE CHECKLISTS

## INTRODUCTION

Proper inspection and ongoing maintenance are essential for green infrastructure to be effective. A post-construction inspection should occur as soon as construction is complete, and maintenance inspections should occur regularly, at least once or twice per year, for the life of the practice. This Inspection and Maintenance Guidance focuses on both types of inspection for bioretention and permeable pavement green infrastructure practices.

An inspector undertaking a post-construction inspection evaluates the ability of a newly installed green infrastructure practice to perform effectively and as planned. The inspector evaluates the constructed green infrastructure practice against approved design drawings and plans. The post-construction inspection checklist provided in Appendix B can be used to ensure that green infrastructure is properly constructed as designed and that stormwater management will be effective.

Ongoing maintenance of green infrastructure includes both routinely scheduled activities (e.g., landscape maintenance) and non-routine activities that may be required after large storms (e.g., sediment removal and redistribution of mulch). Urban Drainage and Flood Control District (UDFCD) presents maintenance considerations, in addition to specifications and standards, in Urban Storm Drainage Criteria Manual (USDCM) Volume 3 (UDFCD 2013). A summary of maintenance considerations, maintenance activities and their frequency is presented in Section 2, and a maintenance checklist is provided in Appendix B.

## MAINTENANCE GUIDELINES FOR GREEN INFRASTRUCTURE

Maintenance considerations for bioretention, tree trench and tree pits, and permeable pavement are presented in the following sections. Bioretention maintenance considerations are applicable to streetside stormwater planters, bumpout stormwater planters, and green gutters. The permeable pavement maintenance considerations can be applied to green alley applications and permeable pavement areas integrated into tree trench/pit and bioretention configurations.

## BIORETENTION

The primary maintenance requirement for bioretention is regular plant, soil, and mulch layer (if applicable) maintenance to ensure a healthy vegetation system that promotes infiltration, storage, and pollutant removal. A healthy and densely vegetated system should be free of excess sediment and trash, and the system typically should drain within 12 hours of a storm. Replacement of vegetation may be necessary to maintain optimal performance. Bioretention maintenance requirements are applicable to all forms of bioretention. Maintenance is typical of general landscape care and consists of the following:

- Sediment removal.** Sweep or shovel sediment from the sediment collection pad/forebay after each storm event, approximately two times per year or as needed after storm events. Dispose of sediment outside the planter.
- Watering.** Vegetation must be drought-tolerant and generally should not require watering after a 2- to 3-year establishment period. Watering could be required during prolonged dry periods after vegetation has been established.
- Debris and litter removal.** Remove debris and litter from the infiltration surface to minimize clogging of the media. If applicable, remove debris and litter from the overflow structure. The degree of debris and litter accumulation is variable and is influenced by surrounding land uses, pedestrian traffic or activities, and the presence of trees.
- Landscaping.** Mow grasses as desired or needed for weed control. Native or drought-tolerant grasses should be maintained at a height of at least 6 inches; mowing may not be necessary. Occasional pruning or removal of dead plant or tree material (e.g., leaf litter) and periodic weeding may be necessary depending on the plants chosen. Periodic weeding may be necessary during the establishment period until the soil media is covered with mulch or dense vegetation.

## APPENDIX B: INSPECTION & MAINTENANCE CHECKLISTS

- Mulch.** In areas where heavy metal deposition is likely (e.g., contributing areas that include industrial and auto-related businesses, parking lots, and roads) replace mulch annually. In areas where metal deposition is not a concern, add mulch as needed to maintain a mulch depth of up to 3 inches. Mulch should be replaced every 2 to 5 years where metal deposition is not a concern.
- Nutrients and pesticides.** Bioretention soil mix and plants are selected for optimum fertility, plant establishment, and growth. Nutrients and pesticides should not be applied, as they can degrade the pollutant removal capability of the bioretention system and contribute pollutant loads to receiving waters.
- Inlet.** Inlets should be inspected for sediment accumulation and signs of erosion. Excess sediment can accumulate at inlets where curb cuts or bypass structures are used and should be inspected regularly. Any accumulated sediment that impedes flow into the bioretention area should be removed and properly disposed (not placed elsewhere in the planter). When the system is first installed, inlets should be inspected after each storm event to identify any potential inflow and sediment issues that require design modifications. Subsequently inlets should be inspected after the first storm of the season and then monthly during the rainy season.
- Overflow and underdrains.** Sediment accumulation in the overflow device or underdrain system can cause prolonged ponding and potential flooding. Excess ponding can damage vegetation and create mosquito-breeding habitat. Overflow and underdrain systems should be inspected to ensure that cleanouts are watertight and there is no visible debris inside the overflow structure.

Inspection of bioretention practices should occur at least twice annually following runoff-generating storms to determine if the practice is providing acceptable infiltration. If standing water persists for more than 24 hours after runoff has ceased, clogging should be investigated and remedied. Areas where erosion has occurred should be inspected, as these are potential sources of sediment if not repaired.

### TREE TRENCH OR TREE PIT

Maintenance for tree trenches or tree pits is necessary for tree health and to ensure a functioning system where water is conveyed through the inlet and throughout the system effectively. Typical maintenance of tree trenches or tree pits consists of the following:

- Debris and litter removal.** Remove debris and litter from the infiltration surface to minimize clogging of the media. The degree of debris and litter accumulation is variable and is influenced by surrounding land uses, pedestrian traffic or activities and season (tree litter is expected each fall).
- Landscaping.** Occasional pruning, removal of dead tree material (e.g., leaf litter) and periodic weeding may be necessary.
- Inlet.** Inlets should be inspected for sediment accumulation and signs of erosion. Excess sediment can accumulate at inlets where curb cuts or bypass structures are used and should be inspected regularly. Any accumulated sediment that impedes flow into the tree trench or tree pit should be removed and properly disposed (not placed elsewhere in the planter). When the system is first installed, inlets should be inspected after each storm event to identify any potential inflow and sediment issues that require design modifications. Subsequently inlets should be inspected after the first storm of the season and then monthly during the rainy season.
- Forebay.** The aggregate in the forebay should be vacuumed regularly (monthly during the wet season is recommended) and replaced routinely (when significant clogging is observed). Maintenance frequency is dependent on the rate the media clogs. Media clogging is a function of drainage area size, presence or amount of construction activity, and the pollutant loads in the runoff. Inspections are recommended once or twice per year to detect early visual signs of clogging.



## APPENDIX B: INSPECTION & MAINTENANCE CHECKLISTS

- Overflow and underdrains.** Sediment accumulation in the overflow device or underdrain system can cause prolonged ponding and potential flooding. Excess ponding can damage the soil media and create mosquito-breeding habitat. Overflow and underdrain systems should be inspected to ensure that cleanouts are watertight and there is no visible debris inside the overflow structure.

Inspection of tree trenches or tree pits should occur at least twice annually following runoff-generating storms to determine if runoff is flowing through the system properly. If standing water persists for more than 24 hours after runoff has ceased, clogging should be investigated and remedied. Areas where erosion has occurred should be inspected, as these are potential sources of sediment if not repaired.

### PERMEABLE PAVEMENT

The key maintenance objective for permeable pavement systems is to prevent void spaces from becoming clogged or requiring sediment removal. Infiltration issues can be identified when runoff ponds on the surface or is no longer infiltrating into the surface rapidly. Key maintenance considerations and procedures consist of the following (refer to USDCM Volume 3 for further details regarding specific permeable pavement types):

- Debris removal, sweeping, and vacuuming.** Debris should be removed routinely as a source control measure. Sweeping with a regenerative air sweeper (not a broom sweeper) should be performed approximately two times per year. Frequency can be adjusted according to the run-on ratio and deposition rate on the permeable pavement surface. Frequent sweeping is an excellent measure to prevent clogging, and sweeping with a vacuum sweeper has shown to be effective for removing solids and debris from the void space of permeable pavement.
- Weed control.** Weed control applications should be used on any weeds that grow in permeable pavement. Where underdrains provide a hard connection to a storm drain, weeds should be spot-treated with an herbicide not containing polyethoxylated amine (POEA). Weeds should not be pulled, as doing so can damage the fill media.
- Snow removal.** Plowing is a recommended snow removal process. Conventional liquid treatments (deicers) will not stay at the surface of a permeable pavement as needed to be effective. Sand should never be applied to a permeable pavement, as it will reduce infiltration.

Inspection of pavement condition and verification of infiltration should be performed at least annually, either during a rain event or with a garden hose to ensure that water infiltrates into the surface.

### REFERENCE

UDFCD (Urban Drainage and Flood Control District). 2013, August. Urban Storm Drainage Criteria Manual Volume 3. Accessed July 7, 2014. [http://www.udfcd.org/downloads/down\\_critmanual\\_volIII.htm](http://www.udfcd.org/downloads/down_critmanual_volIII.htm).

APPENDIX B: INSPECTION & MAINTENANCE CHECKLISTS

**BIORETENTION**

Streetside Stormwater Planters, Bumpout Stormwater Planters, and Green Gutters

Inspection Item	Yes	No	N/A	Corrective Action (if “no”)
1. Will site runoff enter the practice as intended?	<input type="checkbox"/>	<input type="checkbox"/>	<input type="checkbox"/>	
2. Will flow be evenly dispersed following the inlet? Are there signs of or potential for concentrated flow?	<input type="checkbox"/>	<input type="checkbox"/>	<input type="checkbox"/>	
3. Will site runoff enter the practice as intended?	<input type="checkbox"/>	<input type="checkbox"/>	<input type="checkbox"/>	
4. Do the bioretention dimensions match those specified in the construction drawings?	<input type="checkbox"/>	<input type="checkbox"/>	<input type="checkbox"/>	
5. Are step-out zone dimensions (if applicable) according to plans?	<input type="checkbox"/>	<input type="checkbox"/>	<input type="checkbox"/>	
6. Are pedestrian barriers in place and sized according to plans?	<input type="checkbox"/>	<input type="checkbox"/>	<input type="checkbox"/>	
7. Are underdrains installed? If so, are the slots oriented and sized according to the plans?	<input type="checkbox"/>	<input type="checkbox"/>	<input type="checkbox"/>	
8. If applicable, are underdrain cleanouts visible and sealed? If in a valve box, ensure filter material has also been placed between the valve box and cleanout.	<input type="checkbox"/>	<input type="checkbox"/>	<input type="checkbox"/>	
9. If applicable, are cleanouts configured according to plans and located a maximum of every 300 feet? Are riser pipes solid (not slotted)?	<input type="checkbox"/>	<input type="checkbox"/>	<input type="checkbox"/>	
10. Are walls and spillway constructed as planned?	<input type="checkbox"/>	<input type="checkbox"/>	<input type="checkbox"/>	
11. Is the distance from the surface of the filter area to the outflow (spillway and top of the weir inside the water control structure) appropriate to provide the ponding depth per the construction drawing?	<input type="checkbox"/>	<input type="checkbox"/>	<input type="checkbox"/>	
12. Is the outlet control weir set to the elevation shown on the construction drawings?	<input type="checkbox"/>	<input type="checkbox"/>	<input type="checkbox"/>	
13. Does the bioretention media match the description of the media provided in the submittal?	<input type="checkbox"/>	<input type="checkbox"/>	<input type="checkbox"/>	
14. Has the bioretention media infiltration rate been tested according to the plans and specifications? Verify infiltration rate test records.	<input type="checkbox"/>	<input type="checkbox"/>	<input type="checkbox"/>	
15. If applicable, is mulch finely shredded hardwood and 3 inches in depth?	<input type="checkbox"/>	<input type="checkbox"/>	<input type="checkbox"/>	

## APPENDIX B: INSPECTION & MAINTENANCE CHECKLISTS

16. If plans include a liner, is it sufficiently covered by media and not visible?	<input type="checkbox"/>	<input type="checkbox"/>	<input type="checkbox"/>	
17. If applicable, ensure weed barrier is not used under mulch or rock.	<input type="checkbox"/>	<input type="checkbox"/>	<input type="checkbox"/>	
18. Is the vegetation the type, size, and maturity as specified in the plans? (e.g., grasses versus plantings, seed versus sod)	<input type="checkbox"/>	<input type="checkbox"/>	<input type="checkbox"/>	
19. If sod is used, it is sand-grown sod?	<input type="checkbox"/>	<input type="checkbox"/>	<input type="checkbox"/>	
20. Is the vegetation planted and staked properly according to the plans? (e.g., orientation, proximity, overall placement)	<input type="checkbox"/>	<input type="checkbox"/>	<input type="checkbox"/>	
21. Does vegetation appear healthy?	<input type="checkbox"/>	<input type="checkbox"/>	<input type="checkbox"/>	

### TREE TRENCH / PIT

Inspection Item	Yes	No	N/A	Corrective Action (if "no")
1. Will site runoff enter the practice as intended?	<input type="checkbox"/>	<input type="checkbox"/>	<input type="checkbox"/>	
2. Is pretreatment filter in place according to construction drawings? Is there at least 6 inches of fall from the invert of the chase to the top of the aggregate?	<input type="checkbox"/>	<input type="checkbox"/>	<input type="checkbox"/>	
3. Do the tree trench/tree pit dimensions match those specified in the construction drawings?	<input type="checkbox"/>	<input type="checkbox"/>	<input type="checkbox"/>	
4. Are step-out zone dimensions according to plans?	<input type="checkbox"/>	<input type="checkbox"/>	<input type="checkbox"/>	
5. Are underdrains installed? If so, are the slots oriented and sized according to the plans?	<input type="checkbox"/>	<input type="checkbox"/>	<input type="checkbox"/>	
6. If applicable, are underdrain cleanouts visible and sealed? If in a valve box, ensure filter material has also been placed between the valve box and cleanout.	<input type="checkbox"/>	<input type="checkbox"/>	<input type="checkbox"/>	
7. If applicable, are cleanouts configured according to plans and located a maximum of every 300 feet, with cleanouts at every junction and bend in the pipe? Are riser pipes solid (not slotted)?	<input type="checkbox"/>	<input type="checkbox"/>	<input type="checkbox"/>	
8. Is the distance from the surface of the tree area (filter area) to the tree gate as specified in the plans?	<input type="checkbox"/>	<input type="checkbox"/>	<input type="checkbox"/>	
9. Is the outlet control weir set to the elevation shown on the construction drawings?	<input type="checkbox"/>	<input type="checkbox"/>	<input type="checkbox"/>	
10. Does the bioretention media match the description of the media provided in the submittal?	<input type="checkbox"/>	<input type="checkbox"/>	<input type="checkbox"/>	

## APPENDIX B: INSPECTION & MAINTENANCE CHECKLISTS

11. Has the bioretention media infiltration rate been tested according to the plans and specifications? Verify infiltration rate test records.	<input type="checkbox"/>	<input type="checkbox"/>	<input type="checkbox"/>	
12. If applicable, is mulch finely shredded hardwood and 3 inches in depth?	<input type="checkbox"/>	<input type="checkbox"/>	<input type="checkbox"/>	
13. If plans include a liner, is it sufficiently covered by media and not visible?	<input type="checkbox"/>	<input type="checkbox"/>	<input type="checkbox"/>	
14. If applicable, ensure weed barrier is not used under mulch or rock.	<input type="checkbox"/>	<input type="checkbox"/>	<input type="checkbox"/>	
15. Is the tree type, size, and maturity as specified in the plans?	<input type="checkbox"/>	<input type="checkbox"/>	<input type="checkbox"/>	
16. If multiple trees, are the trees spaced according to the plans?	<input type="checkbox"/>	<input type="checkbox"/>	<input type="checkbox"/>	
17. Does tree appear healthy?	<input type="checkbox"/>	<input type="checkbox"/>	<input type="checkbox"/>	

### PERMEABLE PAVEMENT

#### Common Elements

Inspection Item	Yes	No	N/A	Corrective Action (if "no")
1. Does the alley drainage area appear to drain centrally towards the permeable pavement (away from buildings)?	<input type="checkbox"/>	<input type="checkbox"/>	<input type="checkbox"/>	
2. Is the width of the permeable pavement as specified in the plans? Is the surface even with no evidence of cracks?	<input type="checkbox"/>	<input type="checkbox"/>	<input type="checkbox"/>	
3. Is there indication of a non-water liquid layer, heavy stain or paint, oil sheen, or odor?	<input type="checkbox"/>	<input type="checkbox"/>	<input type="checkbox"/>	
4. Is the storage or structural layer firm and unyielding?	<input type="checkbox"/>	<input type="checkbox"/>	<input type="checkbox"/>	
5. Is a transition strip of standard concrete provided at all transitions from asphalt to permeable pavement unless otherwise specified in the plans?	<input type="checkbox"/>	<input type="checkbox"/>	<input type="checkbox"/>	
6. Are underdrains installed? If so, are the slots oriented and sized according to the plans?	<input type="checkbox"/>	<input type="checkbox"/>	<input type="checkbox"/>	
7. If applicable, are underdrain cleanouts visible and sealed? If in a valve box, ensure filter material has also been placed between the valve box and cleanout.	<input type="checkbox"/>	<input type="checkbox"/>	<input type="checkbox"/>	
8. If applicable, are cleanouts configured according to plans and located a maximum of every 300 feet, with cleanouts at every junction and bend in the pipe? Are riser pipes solid (not slotted)?	<input type="checkbox"/>	<input type="checkbox"/>	<input type="checkbox"/>	

APPENDIX B: INSPECTION & MAINTENANCE CHECKLISTS

9. Is the outlet constructed per construction drawings?	<input type="checkbox"/>	<input type="checkbox"/>	<input type="checkbox"/>	
<b>PCIP</b>	<b>Yes</b>	<b>No</b>	<b>N/A</b>	<b>Corrective Action (if “no”)</b>
1. Is a leveling layer of washed No. 8 stone included between the structural layer and the permeable interlocking concrete paver?	<input type="checkbox"/>	<input type="checkbox"/>	<input type="checkbox"/>	
2. Are all voids filled with washed No. 8 stone to the surface of the interlocking concrete paver?	<input type="checkbox"/>	<input type="checkbox"/>	<input type="checkbox"/>	
3. Is the pavement surface firm and unyielding?	<input type="checkbox"/>	<input type="checkbox"/>	<input type="checkbox"/>	
4. If for vehicular use, is the outer edge of PICP area bordered by concrete, and are uncut blocks used adjacent to the concrete border?	<input type="checkbox"/>	<input type="checkbox"/>	<input type="checkbox"/>	
5. Are cut pavers at least 40% of their uncut size?	<input type="checkbox"/>	<input type="checkbox"/>	<input type="checkbox"/>	
6. Is a herringbone pattern used for PICP areas intended for vehicular traffic?	<input type="checkbox"/>	<input type="checkbox"/>	<input type="checkbox"/>	
<b>Concrete Grid Pavers</b>	<b>Yes</b>	<b>No</b>	<b>N/A</b>	<b>Corrective Action (if “no”)</b>
1. Is the outer edge of the paver area bordered by concrete?	<input type="checkbox"/>	<input type="checkbox"/>	<input type="checkbox"/>	
2. If uncut blocks are used, are they adjacent to the concrete border?	<input type="checkbox"/>	<input type="checkbox"/>	<input type="checkbox"/>	
3. If visible, does the bedding layer consist of No. 8 stone unless otherwise specified in the plans?	<input type="checkbox"/>	<input type="checkbox"/>	<input type="checkbox"/>	
4. If vegetation is specified, is the grid paver filled with a soil media or seeded according to the plan?	<input type="checkbox"/>	<input type="checkbox"/>	<input type="checkbox"/>	

**MAINTENANCE CHECKLIST FOR GREEN INFRASTRUCTURE**

FACILITY INFORMATION	
PROPERTY OWNER:	INSPECTION DATE:
PROPERTY ADDRESS:	INSPECTION TYPE:
INSPECTOR(S):	<input type="checkbox"/> After first rainfall event of season <input type="checkbox"/> Monthly (during wet season) <input type="checkbox"/> Other: _____
TYPE(S) PRESENT:	
<b>BIORETENTION</b> <input type="checkbox"/> Streetside Stormwater Planter <input type="checkbox"/> Tree Trench/PIT <b>PERMEABLE PAVEMENT (GREEN ALLEY)</b> <input type="checkbox"/> Concrete Grid Pavement	<input type="checkbox"/> Bumpout Stormwater Planter <input type="checkbox"/> Tree Pit <input type="checkbox"/> Porous Gravel <input type="checkbox"/> Reinforced Grass
<input type="checkbox"/> Green Gutter	
POST INSPECTION SUMMARY:	
Empty space for post-inspection summary	

# APPENDIX C: PLANT LISTS

Streetside Stormwater Planter and Bumpout Stormwater Planter Plant List							
Scientific Name	Common Name	Water Needs	Exposure Sun/Shade	Size Height + Spread	Recommended Container Size + Spacing	Maintenance	Comments
<b>GRASSES</b>							
Andropogon gerardii 'Dancing Wind'	Dancing Wind Big Bluestem	Drought Tolerant	Sun	4' in bloom; rhizomatous	plug or qt; 2-3' spacing	cut back in late winter	red fall color; CN
Winter Andropogon gerardii 'P003S'	Windwalker Big Bluestem	Drought Tolerant	Sun	4' in bloom; rhizomatous	plug or qt; 4' spacing	cut back in late winter	Powder blue foliage; CN
Winter Calamagrostis x acutiflora 'Karl Forester'	Feather Reed Grass	Drought Tolerant	Sun, filtered shade	3-4' height	plug or qt; 2-3' spacing	cut back in late winter	Greens up early spring; NON
Deschampsia caespitosa	Tufted Hair Grass	Mesic	Sun, shade	2-4' height; 18" - 2' spread	plug or qt; 6" - 18" spacing	cut back in late winter	Shade tolerant; CN
Bouteloua gracilis 'Blonde Ambition'	Blonde Ambition Grama Grass	Xeric	Sun	18" in bloom	plug or qt; 6" - 18" spacing	cut back in late winter	Straw yellow seed heads; CN
Panicum virgatum 'Hot Rod'	Hot Rod Switchgrass	Drought Tolerant	Sun	4-5' in bloom	plug or qt; 4' spacing	cut back in late winter	reddish summer and fall foliage; CN
Panicum virgatum 'Northwind'	Northwind Switchgrass	Drought Tolerant	Sun	4-5' in bloom	plug or qt; 2-3' spacing	cut back in late winter	formal upright foliage; CN
Panicum virgatum 'Prairie Sky'	Prairie Sky	Drought Tolerant	Sun	4-5' in bloom	plug or qt; 2-3' spacing	cut back in late winter	steel blue fine-textured foliage; CN
Schizachirium scoparium 'Prairie Blues'	Prairie Blues Little Bluestem	Drought Tolerant	Sun	3' in bloom	plug or qt; 6" - 18" spacing	cut back in late winter	blue summer foliage, red winter foliage; CN
Muhlenbergia reverchoni 'Undaunted'	Undaunted Ruby Muhly	Drought Tolerant	Sun	3' in bloom	plug or qt; 6" - 18" spacing	cut back in late winter	foliage looks good year round; red fall flowers, N

**Key:**

CN - Colorado Native

Native

N - North American

NON - Non-Native

APPENDIX C: PLANT LISTS

Sporobolus heterolepis	Prairie dropseed	Drought Tolerant	Sun, partial shade	3' in bloom	plug or qt; 6" - 18" spacing	cut back in late winter	lush green foliage; tidy mounded habit; shade tolerant, CN
<b>HERBACEOUS PERENNIALS</b>							
Anaphalis margaritacea	Pearly Everlasting	Drought Tolerant	Sun, partial shade	2-3' tall and wide	plug or qt; 1.5 - 2' spacing	cut back in late winter	long lasting silvery blocks contrast with bushy green foliage; shade tolerant, CN
Anaphalis margaritacea	Prairie Bluebell	Drought Tolerant	Sun	8-10" from a tufted rosette	plug or qt; 6" spacing	cut back in late winter	allow to self sow; N
Helianthus maximiliani 'Dakota Sunshine'	Dakota Sunshine Sunflower	Drought Tolerant	Sun	5' tall by 4' wide, spreading	plug or qt; 6" spacing	cut back in late winter	seed attracts goldfinches, CN
Iris missouriensis blue flag	Blue Flag	Drought Tolerant	Sun, partial shade	20" tall clumping	plug or qt; 3' spacing	cut back in late winter	showy early season bloom, CN
Liatris ligulistylis	Rocky Mountain Gayfeather	Drought Tolerant	Sun, partial shade	3-4' tall, clumping	plug or qt; 1-2' spacing	cut back in late winter	flowers attract Monarch butterflies, CN
Monarda fistulosa	Wild Bergamont	Drought Tolerant	Sun, partial shade	2-4' tall, spreading	plug or qt; 2-3' spacing	cut back in late winter	flowers attract butterflies, hummingbirds; shade tolerant, CN
Monarda bradburiana	Eastern Bergamont	Drought Tolerant	Sun, partial shade	2-4' tall, spreading	plug or qt; 3' spacing	cut back in late winter	flowers attract butterflies, hummingbirds; N
Oenothera fruticosa 'Fireworks' / Fyrveckeri	Fireworks / Fyrveckeri Evening Primrose	Drought Tolerant	Sun, partial shade	12-18" tall and wide	plug or qt; 3' spacing	cut back in late winter	red stems and spring foliage; shade tolerant, N
Penstemon digitalis 'Husker Red'	Husker Red Penstemon	Drought Tolerant	Sun			cut back in late winter	reddish foliage rosettes; spikes of white flowers, N
Phlox paniculata 'Blue Paradise'	Garden Phlox	moderate water requirements	Sun, or shade	3-4' tall	4" pot or Qt; 1-2' spacing	cut back in late winter	shade tolerant, N
Phlox paniculata 'David'	Border Phlox	moderate water requirements	Sun, or shade	3-4' tall by 2-3' wide	4" pot or Qt; 1-2' spacing	cut back in late winter	shade tolerant, N
Ratibida pinnata	Prairie coneflower	Drought Tolerant	Sun	3-6' tall by 2' wide	plug or Qt; 1-2' spacing	cut back in late winter	seed attracts goldfinches, CN
Symphoricarum laeve 'Bluebird' smooth aster	Bluebird smooth aster	Drought Tolerant	Sun, partial shade	3-4' tall by 24-36" wide	plug or Qt; 6' spacing	cut back in late winter	showy fountains of light blue fall flowers; shade tolerant, N

**Key:**

CN - Colorado Native

Native

N - North American

NON - Non-Native



APPENDIX C: PLANT LISTS

<b>BULBS</b>									
Camassia leichtlinii 'Blue Danube'	Blue Danube Wild Hyacinth	Drought Tolerant	Sun, or shade	12-18" tall, clumping	Bulbs, clustered in groups 9 bulbs/SF	cut back after spring bloom	bulb with showy blue flowers mid spring; shade tolerant NON		
<b>SHRUBS</b>									
Amorpha Canescens	Leadplant	Drought Tolerant	Sun, partial shade	2-3' tall and wide	#1 or #5 container; 1-2' spacing	prune to shape in late winter	silver foliage; orange and purple summer bloom; CN		
Dasiphora (Potentilla) Fruticosa var. dahurica 'prairie show'	'Prairie Snow' White Cinquefoil	Drought Tolerant	Sun		#1 or #5 container	prune to shape in late winter	long blooming creamy white flower, tidy habit, CN		
Fallugia Paradoxa	Apache Plume	Xeric	Sun	3-4' tall and wide	#1 or #5 container	prune to shape in late winter	White early summer flowers ripen to feathery pink seed heads showy when backlit, CN		
Prunus besseyi 'Pawnee Buttes'	Pawnee Buttes Sand Cherry	Xeric	Sun	3' tall X 6/8' wide	#1 or #5 container	prune to shape in late winter	Dense mounded habit, clean gray-green foliage, fruit for wildlife, CN		
Rhus trilobata 'Autumn Amber'	Autumn Amber Skunkbush Sumac	Xeric	Sun	3' tall X 6/8' wide	#1 or #5 container	prune to shape in late winter	Reddish fall foliage, red berries, spreading habit, CN		
Spirea betulifolia 'Tor Gold'	Glow Girl Spirea	Moderate	Sun, partial shade	2-3' tall and wide	#1 or #5 container	prune to shape in late winter	Shade tolerant, NON		

**Key:**

- CN - Colorado Native
- N - North American
- Native
- NON - Non-Native

# APPENDIX D: FORESTRY MEMO

## DENVER'S APPROVED STORMWATER FACILITY STREET TREE LIST

Last updated 2.15.15

The following list of tree species are approved for planting in green infrastructure stormwater facilities within Denver rights-of-way.

Please note that this list may change overtime based on experience and species performance.

City Forester issued planting and removal permits are required prior to the removal or planting of trees within Denver rights-of-way.

Trees not included in this list may be permitted on a case-by-case basis.

Please contact the Office of the City Forester for more information on planting trees within stormwater facilities or to request tree permits.

### **The following are standard spacing requirements for street trees in Denver:**

- 35' between shade trees
- 25' between ornamental trees
- 30' from curb at intersections
- 20' from street lights
- 10' from alleys, driveways & fire hydrants

### **TREE LIST LEGEND**

Shading indicates species suitable for planting under overhead utilities. These varieties should only be planted in situations where overhead growth restrictions exist.

APPENDIX D: FORESTRY MEMO

Botanical Name	Acceptable Cultivar(s)	Common Name	Zone	Moisture Level	Soil Salt Tolerance	Height at Maturity	Canopy Spread at Maturity	General Habit, Foliage, Flowers	Additional Notes
Acer miyabei	State Street	Miyabe Maple	4	Mod	Tolerant	40	25	Upright, oval form; Dark green foliage turning yellow in fall	Fast Grower
Acer tataricum	Hot Wings, Rugged Charm	Tatarian Maple	3	Xeric	Intermediate to Tolerant	20	20	Rounded, sometimes irregular outline; softer green in summer than Amur maple; yellow autumn color, sometimes red	Rarely suckers, pruning to maintain outline, heavy seed crop
Catalpa speciosa		Northern Catalpa	4	Min to Mod	Intermediate	60	40	Open form tree with a narrow, irregular, oval crown; very large single leaves, white orchid like flowers followed by 10" long cigar-like seeds	Very tolerant of poor quality, alkaline soils; fall color is yellow to brown
Celtis laevigata	All Seasons	Sugar Hackberry	5	Xeric to Min	Tolerant	60	40	Rounded to broad rounded with slightly pendulous branching in maturity, simple and lanceolate to narrow ovate glossy and green to dull yellow in fall.	Can be cold sensitive; borderline zone rating
Celtis occidentalis		Common Hackberry	3	Xeric to Min	Tolerant	60	45	Pyramidal when young, irregular-rounded when mature; light to medium green in summer, yellow in fall	Very susceptible to Nipple Rot, aesthetic problem unless major and repeated infestation
Crataegus ambigua		Russian Hawthorn	4	Xeric	Unknown	20	20	Rounded canopy with showy, exfoliating bark; small, finely cut medium-green leaves	Has the occasional small thorn but is essentially thornless
Crataegus crus-galli inermis		Thornless Cockspur Hawthorn	4	Xeric	Tolerant	20	25	Round with strongly horizontal branching; glossy dark green in summer, orange in fall	Shape makes maintaining clearance difficult. Structure pruning when young is important.
Ginkgo biloba	Autumn Gold	Ginkgo	4	Mod	Intermediate	45	35	Symmetrically pyramidal when young, broad spreading with age; unique fan-shaped leaves with excellent gold fall color	Male clone, fruitless. Slow grower
Gleditsia triacanthos inermis	Imperial	Thornless Honeylocust	4	Xeric	Tolerant	60	40	Broadly rounded, good horizontal branching angles; compound ovate leaflets green to yellow in fall. Skyline best structure of group.	Essentially fruitless; over-used in landscape design
Gleditsia triacanthos inermis	Moraine, Northern Acclaim, Shademaster, Skyline	Thornless Honeylocust	4	Xeric	Tolerant	45	35	Vase shaped, rounded, flat topped with maturity; compound ovate leaflets green to yellow in fall. Skyline best structure of group.	Essentially fruitless; over-used in landscape design
Gymnocladus dioicus	Espresso	Kentucky Coffeetree	4	Xeric	Intermediate	60	40	Sparse branching when young; oval to vase shaped, upward branching, filtered shade; leaves emerge late spring; blue green in summer and yellow fall color	Female has fruit litter. Espresso is a fruitless cultivar.
Koeleruteria paniculata		Goldenraintree	4	Xeric	Intermediate	30	30	Irregular rounded, open; purple red while emerging, bright green to blue-green in summer, yellow in autumn	Volunteer seedlings could be problematic in neglected spaces
Malus cv	Any 1/2" or smaller-fruiting non-pendulous variety	Crabapple		Min to Mod		20	25	Variable by cultivar; variable leaves	Pruning for street use
Platanus occidentalis		American Sycamore	4	Mod	Intermediate	75	50	Pyramidal to rounded; large leaves, green in summer to yellow in autumn	Large root system. Fruit litter. Requires a tree lawn at least 8 ft. wide
Platanus x acerifolia	Bloodgold		5	Mod	Intermediate	70	60	Pyramidal when young, open and spreading with age; bark is extremely showy, mottled with cream, olive and light brown colors; medium to dark green leaves in summer; yellow-brown in fall	1' globe shaped (syncarp), pendulous, on long stalks; large root system. P. occidentalis x P. orientalis.
Pyrus calleryana	Aristocrat, Autumn Blaze, Redspire	Callery Pear	5	Min to Mod	Intermediate	35	25	Upright pyramidal to oval; glossy green leaves turning copper-red to red-purple in autumn, showy white clusters in spring	Possible storm damage given branch angles and density; firelight is rare
Pyrus calleryana	Chanticleer, Whitehouse	Chanticleer Pear	5	Min to Mod	Intermediate	30	15	Narrow pyramidal with strong central leader; green to reddish-purple in fall; showy white clusters in spring	Possible storm damage given branch angles and density; firelight rare. Chanticleer is alternatively known as Cleveland.

APPENDIX D: FORESTRY MEMO

Botanical Name	Acceptable Cultivar(s)	Common Name	Zone	Moisture Level	Soil Salt Tolerance	Height at Maturity	Canopy Spread at Maturity	General Habit, Foliage, Flowers	Additional Notes
<i>Quercus bicolor</i>		Swamp White Oak	4	Xeric	Intermediate to Sensitive	50	50	Broad, rounded, open typically has shorter trunk; bark is attractive, grayish-brown, and flaky; Lustrous, leathery dark green in summer, yellowish in the fall and sometimes purple-red	Acorns in heavy crops every 3-5 years
<i>Quercus macrocarpa</i>		Bur Oak	3	Xeric	Tolerant	60	60	Weakly pyramidal to oval in youth, broadly rounded and open with age; leathery, lustrous dark green in summer, yellow-green to yellow-brown in autumn	Acorns
<i>Quercus robur</i>		English Oak	4	Xeric to Min	Intermediate to Tolerant	55	50	Columnar cultivars available, but usually broadly round and oval; Foliage dark green to blue-green in summer, brown in autumn	Long, slender acorns
<i>Quercus x macdanielli</i>	Heritage	MacDaniel's Oak	4	Xeric to Min	Mod	70	45	Fast growing. When young is a pyramidal tree that matures into a wide, oval form with a strong central leader. Leaves are a deep, glossy green	Hybrid of Q. robur x Q. macrocarpa. Acorns.
<i>Styphonolobium japonicum</i>	Regent	Japanese Pagodatree; Scholar tree	4	Min	Intermediate	40	40	Oval to round, upright sprouting branches, frequently wider than tall; lustrous bright green in summer, yellowish in fall, late to turn color in fall	Storm damage an occasional concern. Formerly known as Sophora japonica.
<i>Syringa reticulata</i>	Morton	China Snow Lilac	4	Xeric to Min	Intermediate	15	15	Upright then rounded and spreading; simple dark green to yellow in fall; creamy white panicles in June	Regular pruning to maintain single stem, and avoid drooping lower limbs
<i>Syringa pekinensis</i>	Brandon; New Harmony; Princeton; Valley Forge	Japanese Tree Lilac	3	Xeric to Min	Intermediate	25	20	Spreading rounded vase; green leaves, no autumn color; showy, white flowers in early summer	Needs pruning for single trunk; leaves out early and frequently suffer frost damage in spring
<i>Ulmus americana</i>	Ivory Silk	American Elm	4	Mod	Tolerant	70	60	Broadly vase-shaped; green leaves in summer, yellow in autumn	Winter decidation may be problematic, listed cultivars show good resistance to Dutch Elm Disease
<i>Ulmus japonica</i>	Discovery	Japanese Elm	3	Mod	Unknown	35	30	Similar in outline to American elm; dark green summer foliage; yellow in fall	DED and ELB resistant
<i>Ulmus parvifolia</i>	Emer II	Allee Lacebark Elm	5	Mod	Unknown	45	40	Upright, arching vase resembling American Elm; dark green in summer; yellow to red in autumn	DED resistant
<i>Ulmus wilsoniana</i>	Prospector	Prospector Elm	4	Min to Mod	Unknown	40	30	Vase-shaped; large leaves emerge with red/orange tint; yellow in autumn	DED and ELB resistant
<i>Zelkova serrata</i>	Green Veil	Japanese Zelkova	5	Min to Mod	Unknown	40	40	Upright arching branches forming vase shape; taller and narrower than village green; green to yellow in fall	Pruning for structure
<i>Zelkova serrata</i>	Halka	Japanese Zelkova	5	Min to Mod	Unknown	45	15	Fastest growing; upright vase; medium green to yellow	
<i>Zelkova serrata</i>	Musashino	Japanese Zelkova	5	Min to Mod	Unknown	50	35	Narrow upright vase; medium green to yellow/orange in fall; smaller leaves than other Zelkovas.	Adaptable to urban conditions, not proven in Colorado environment for snow loads
<i>Zelkova serrata</i>	Village Green	Japanese Zelkova	5	Min to Mod	Unknown	50	45	Fast growing, upright rounded vase with straighter trunk; dark green to variable red in autumn	Insignificant fruit litter; pruning for structure and snow load; most cold hardy cultivar





**DENVER**  
PUBLIC WORKS